



REPUBLIC OF THE PHILIPPINES  
**NATIONAL POWER CORPORATION**  
(Pambansang Korporasyon sa Elektrisidad)

## **BID DOCUMENTS**

**Name of Project : CONSTRUCTION OF ADDITIONAL BREASTING  
STRUCTURES FOR POWER BARGE 120 AT  
MOGPOG MARINDUQUE**

**Project Location : BALANACAN PORT, MOGPOG, MARINDUQUE**

**Specs No. : LuzP23Z1586Sc**

**Contents:**

|                     |  |
|---------------------|--|
| <b>Section I</b>    | - <b>Invitation to Bid</b>   |
| <b>Section II</b>   | - <b>Instructions To Bidders</b>   |
| <b>Section III</b>  | - <b>Bid Data Sheet</b>  |
| <b>Section IV</b>   | - <b>General Conditions of Contract</b>  |
| <b>Section V</b>    | - <b>Special Conditions of Contract</b>  |
| <b>Section VI</b>   | - <b>Technical Specifications</b> <ul style="list-style-type: none"><li>• <b>Project Highlights</b></li><li>• <b>Civil Works</b></li></ul> |
| <b>Section VII</b>  | - <b>Bill of Quantities</b>  |
| <b>Section VIII</b> | - <b>Bidding Forms</b>   |
| <b>Section IX</b>   | - <b>Bid Drawings</b>  |

**Design and Development Department**



SECTION I

**INVITATION TO BID**





# National Power Corporation

## INVITATION TO BID

### PUBLIC BIDDING – BCS 2023-0538

1. The NATIONAL POWER CORPORATION (NPC), through its approved Corporate Budget of CY 2023 intends to apply the sum of **(Please see schedule below)** being the Approved Budget for the Contract (ABC) to payments under the contract. Bids received in excess of the ABC shall be automatically rejected at Bid opening.

| PR Nos./PB Ref No. & Description   | Similar Contracts  | Pre-bid Conference           | Bid Submission / Opening      | ABC/ Amt. of Bid Docs           |
|--|--|------------------------------|-------------------------------|---------------------------------|
| HO-PIB23-003 /<br>PB230829-NA00232 (PB3)<br><br>Construction of Additional Breasting Structures for Power Barge 120 at Mogpog Marinduque<br><br>• PCAB License: License Category of at least <b>“Category D – General Engineering”</b> and registration classification of at least <b>“Small B – Port, Harbor or Offshore Engineering”</b> OR at least <b>“Category D – General Building”</b> and registration classification of at least <b>“Small B – Building and Industrial Plant”</b> | Construction / Rehabilitation of Mooring Facilities, Piers, Port Terminal or Loading / Unloading Jetty | 24 October 2023<br>9:30 A.M. | 07 November 2023<br>9:30 A.M. | ₱ 6,832,000.00 /<br>₱ 10,000.00 |
| <b>Venue: Kañao Function Room, NPC Bldg. Diliman, Quezon City</b>  |  |                              |                               |                                 |

2. The NPC now invites bids for Items listed above. Delivery of the Goods is required (**see table below**) specified in the Technical Specifications. Bidders should have completed, within (**see table below**) from the date of submission and receipt of bids, a contract similar to the Project. The description of an eligible bidder is contained in the Bidding Documents, particularly, in Section II. (Instruction to Bidders).

| PR No/s. / PB Ref No/s. | Delivery Period / Contract Duration | Relevant Period of SLCC reckoned from the date of submission & receipt of bids |
|-------------------------|-------------------------------------|--|
| HO-PIB23-003            | Sixty (60) Calendar Days            | -  |

3. Bidding will be conducted through open competitive bidding procedures using a non-discretionary *“pass/fail”* criterion as specified in the 2016 revised Implementing Rules and Regulations (IRR) of Republic Act (RA) No. 9184.

Bidding is restricted to Filipino citizens/sole proprietorships, partnerships, or organizations with at least sixty percent (60%) interest or outstanding capital stock belonging to citizens of the Philippines, and to citizens or organizations of a country the laws or regulations of which grant similar rights or privileges to Filipino citizens, pursuant to RA 5183.

4. Prospective Bidders may obtain further information from National Power Corporation, Bids and Contracts Services Division and inspect the Bidding Documents at the address given below during office hours (8:00AM to 5:00PM), Monday to Friday.
5. A complete set of Bidding Documents may be acquired by interested Bidders from the given address and website(s) and upon payment of the applicable fee for the Bidding Documents, pursuant to the latest Guidelines issued by the GPPB. *Bidding fee may be refunded in accordance with the guidelines based on the grounds provided under Section 41 of R.A. 9184 and its Revised IRR.*

6. The National Power Corporation will hold Pre-Bid Conference (**see table above**) and/or through video conferencing or webcasting which shall be open to prospective bidders. Only registered bidder/s shall be allowed to participate in the conduct of virtual pre-bid conference. **Unregistered bidders** may attend the Pre-Bid Conference at the Kañao Room, NPC subject to the following:
  - a. Only a maximum of two (2) representatives from each bidder / company shall be allowed to participate during the virtual pre-bid conference.
  - b. Wearing of Face Masks is recommended but not required in view of Proclamation No. 297 S.2023 lifting the State of Public Health Emergency Throughout the Philippines
  - c. The requirements herein stated including the medium of submission shall be subject to GPPB Resolution No. 09-2020 dated 07 May 2020
  - d. The Guidelines on the Implementation of Early Procurement Activities (EPA) shall be subject to GPPB Circular No. 06-2019 dated 17 July 2019
7. Bids must be duly received by the BAC Secretariat through (i) manual submission at the office address indicated below; (ii) online or electronic submission before the specified time stated in the table above for opening of bids. Late bids shall not be accepted.
8. All Bids must be accompanied by a bid security in any of the acceptable forms and in the amount stated in ITB Clause 14.
9. Bid opening shall be on Kañao Function Room, NPC Head Office, Diliman, Quezon City and/or via online platform to be announced by NPC. Bids will be opened in the presence of the bidders' representatives who choose to attend the activity.
10. The National Power Corporation reserves the right to reject any and all bids, declare a failure of bidding, or not award the contract at any time prior to contract award in accordance with Sections 35.6 and 41 of the 2016 revised IRR of R.A. No. 9184, without thereby incurring any liability to the affected bidder or bidders.
11. For further information, please refer to:  
**Bids and Contracts Services Division,  
Logistics Department**  
BIR Road cor. Quezon Avenue  
Diliman, Quezon City  
Tel Nos.: 8924-5211 and 8921-3541 local 5564/5211  
Email: [bcsd@napocor.gov.ph](mailto:bcsd@napocor.gov.ph) /
12. You may visit the following websites:

For downloading of Bidding Documents: <https://www.napocor.gov.ph/bcsd/bids.php>



**ATTY. MELCHOR P. RIDULME**  
Vice President, Office of the Legal Counsel and  
Chairman, Bids and Awards Committee

## SECTION II

# INSTRUCTION TO BIDDERS

**SECTION II - INSTRUCTIONS TO BIDDERS****TABLE OF CONTENTS**

| <u>CLAUSE NO.</u> | <u>TITLE</u>   | <u>PAGE NO.</u> |
|-------------------|--|-----------------|
| 1.                | SCOPE OF BID .....   | 1               |
| 2.                | FUNDING INFORMATION.....   | 1               |
| 3.                | BIDDING REQUIREMENTS .....   | 1               |
| 4.                | CORRUPT, FRAUDULENT, COLLUSIVE, COERCIVE, AND OBSTRUCTIVE<br>PRACTICES ..... | 1               |
| 5.                | ELIGIBLE BIDDERS .....   | 1               |
| 6.                | ORIGIN OF ASSOCIATED GOODS.....  | 2               |
| 7.                | SUBCONTRACTS .....   | 2               |
| 8.                | PRE-BID CONFERENCE .....   | 2               |
| 9.                | CLARIFICATION AND AMENDMENT OF BIDDING DOCUMENTS .....                       | 2               |
| 10.               | DOCUMENTS COMPRISING THE BID: ELIGIBILITY AND TECHNICAL<br>COMPONENTS .....  | 2               |
| 11.               | DOCUMENTS COMPRISING THE BID: FINANCIAL COMPONENT.....                       | 3               |
| 12.               | ALTERNATIVE BIDS .....   | 3               |
| 13.               | BID PRICES .....   | 3               |
| 14.               | BID AND PAYMENT CURRENCIES .....   | 4               |
| 15.               | BID SECURITY.....  | 4               |
| 16.               | SEALING AND MARKING OF BIDS .....  | 4               |
| 17.               | DEADLINE FOR SUBMISSION OF BIDS .....  | 4               |
| 18.               | OPENING AND PRELIMINARY EXAMINATION OF BIDS .....                            | 4               |
| 19.               | DETAILED EVALUATION AND COMPARISON OF BIDS.....                              | 5               |
| 20.               | POST QUALIFICATION .....   | 5               |
| 21.               | SIGNING OF THE CONTRACT .....  | 5               |

## SECTION II - INSTRUCTIONS TO BIDDERS

### 1. Scope of Bid

NPC invites Bids for the **CONSTRUCTION OF ADDITIONAL BREASTING STRUCTURES FOR POWER BARGE 120 AT MOGPOG, MARINDUQUE**, with Project Identification Number **LuzP23Z1586Sc**.

The Procurement Project (referred to herein as "Project") is for the construction of Works, as described in Section VI (Specifications).

### 2. Funding Information

The GOP through the source of funding as indicated below for CY 2023 in the amount specified in the Invitation to Bid. The source of funding is the proposed Corporate Operating Budget of the National Power Corporation (NPC).

### 3. Bidding Requirements

The Bidding for the Project shall be governed by all the provisions of RA No. 9184 and its 2016 revised IRR, including its Generic Procurement Manual and associated policies, rules and regulations as the primary source thereof, while the herein clauses shall serve as the secondary source thereof.

Any amendments made to the IRR and other GPPB issuances shall be applicable only to the ongoing posting, advertisement, or invitation to bid by the BAC through the issuance of a supplemental or bid bulletin.

The Bidder, by the act of submitting its Bid, shall be deemed to have inspected the site, determined the general characteristics of the contracted Works and the conditions for this Project, such as the location and the nature of the work; (b) climatic conditions; (c) transportation facilities; (c) nature and condition of the terrain, geological conditions at the site communication facilities, requirements, location and availability of construction aggregates and other materials, labor, water, electric power and access roads; and (d) other factors that may affect the cost, duration and execution or implementation of the contract, project, or work and examine all instructions, forms, terms, and project requirements in the Bidding Documents.

### 4. Corrupt, Fraudulent, Collusive, Coercive, and Obstructive Practices

The Procuring Entity, as well as the Bidders and Contractors, shall observe the highest standard of ethics during the procurement and execution of the contract. They or through an agent shall not engage in corrupt, fraudulent, collusive, coercive, and obstructive practices defined under Annex "I" of the 2016 revised IRR of RA No. 9184 or other integrity violations in competing for the Project.

### 5. Eligible Bidders

- 5.1. Only Bids of Bidders found to be legally, technically, and financially capable will be evaluated.
- 5.2. The bidder must have completed an SLCC that is similar to the contract to be bid, and whose value, adjusted to current prices using the PSA consumer price indices, must be at least fifty percent (50%) of the ABC to be bid: Provided, however, That contractors under Small A and Small B categories

without similar experience on the contract to be bid may be allowed to bid if the cost of such contract is not more than the Allowable Range of Contract Cost (ARCC) of their registration based on the guidelines as prescribed by the PCAB. For Foreign-funded Procurement, the GoP and the foreign government/foreign or international financing institution may agree on another track record requirement.

A contract is considered to be “similar” to the contract to be bid if it has the major categories of work stated in the **BDS**.

- 5.3. For Foreign-funded Procurement, the Procuring Entity and the foreign government/foreign or international financing institution may agree on another track record requirement, as specified in the Bidding Document prepared for this purpose.
- 5.4. The Bidders shall comply with the eligibility criteria under Section 23.4.2 of the 2016 IRR of RA No. 9184.

## **6. Origin of Associated Goods**

There is no restriction on the origin of Goods other than those prohibited by a decision of the UN Security Council taken under Chapter VII of the Charter of the UN.

## **7. Subcontracts**

- 7.1. The Bidder may subcontract portions of the Project to the extent allowed by the Procuring Entity as stated herein, but in no case more than fifty percent (50%) of the Project.
- 7.2. The Bidder must submit together with its Bid the documentary requirements of the subcontractor(s) complying with the eligibility criteria stated in **ITB** Clause 5 in accordance with Section 23.4 of the 2016 revised IRR of RA No. 9184 pursuant to Section 23.1 thereof.
- 7.3. Subcontracting of any portion of the Project does not relieve the Contractor of any liability or obligation under the Contract. The Supplier will be responsible for the acts, defaults, and negligence of any subcontractor, its agents, servants, or workmen as fully as if these were the Contractor's own acts, defaults, or negligence, or those of its agents, servants, or workmen.

## **8. Pre-Bid Conference**

The Procuring Entity will hold a pre-bid conference for this Project on the specified date and time and either at its physical address and/or through videoconferencing/webcasting} as indicated in paragraph 6 of the **IB**.

## **9. Clarification and Amendment of Bidding Documents**

Prospective bidders may request for clarification on and/or interpretation of any part of the Bidding Documents. Such requests must be in writing and received by the Procuring Entity, either at its given address or through electronic mail indicated in the **IB**, at least ten (10) calendar days before the deadline set for the submission and receipt of Bids.



## 10. Documents Comprising the Bid: Eligibility and Technical Components

- 10.1. The first envelope shall contain the eligibility and technical documents of the Bid as specified in **Form NPCSF-INFR-01 - Checklist of Technical and Financial Documents, Section VIII - Bidding Forms.**
- 10.2. If the eligibility requirements or statements, the bids, and all other documents for submission to the BAC are in foreign language other than English, it must be accompanied by a translation in English, which shall be authenticated by the appropriate Philippine foreign service establishment, post, or the equivalent office having jurisdiction over the foreign bidder's affairs in the Philippines. For Contracting Parties to the Apostille Convention, only the translated documents shall be authenticated through an apostille pursuant to GPPB Resolution No. 13-2019 dated 23 May 2019. The English translation shall govern, for purposes of interpretation of the bid.
- 10.3. A valid PCAB License is required, and in case of joint ventures, a valid special PCAB License, and registration for the type and cost of the contract for this Project. Any additional type of Contractor license or permit shall be indicated in the **BDS.**
- 10.4. A List of Contractor's key personnel (e.g., Project Manager, Project Engineers, Materials Engineers, and Foremen) assigned to the contract to be bid, with their complete qualification and experience data shall be provided. These key personnel must meet the required minimum years of experience set in the **BDS.**
- 10.5. A List of Contractor's major equipment units, which are owned, leased, and/or under purchase agreements, supported by proof of ownership, certification of availability of equipment from the equipment lessor/vendor for the duration of the project, as the case may be, must meet the minimum requirements for the contract set in the **BDS.**

## 11. Documents Comprising the Bid: Financial Component

- 11.1. The second bid envelope shall contain the financial documents for the Bid as specified in **Form NPCSF-INFR-01 - Checklist of Technical and Financial Documents, Section VIII - Bidding Forms.**
- 11.2. Any bid exceeding the ABC indicated in paragraph 1 of the **IB** shall not be accepted.
- 11.3. For Foreign-funded procurement, a ceiling may be applied to bid prices provided the conditions are met under Section 31.2 of the 2016 revised IRR of RA No. 9184.

## 12. Alternative Bids

Bidders shall submit offers that comply with the requirements of the Bidding Documents, including the basic technical design as indicated in the drawings and specifications. Unless there is a value engineering clause in the **BDS**, alternative Bids shall not be accepted.

### 13. Bid Prices

All bid prices for the given scope of work in the Project as awarded shall be considered as fixed prices, and therefore not subject to price escalation during contract implementation, except under extraordinary circumstances as determined by the NEDA and approved by the GPPB pursuant to the revised Guidelines for Contract Price Escalation guidelines.

### 14. Bid and Payment Currencies

14.1. Bid prices may be quoted in the local currency or tradeable currency accepted by the BSP at the discretion of the Bidder. However, for purposes of bid evaluation, Bids denominated in foreign currencies shall be converted to Philippine currency based on the exchange rate as published in the BSP reference rate bulletin on the day of the bid opening.

14.2. Payment of the contract price shall be made in Philippine Pesos.

### 15. Bid Security

15.1. The Bidder shall submit a Bid Securing Declaration or any form of Bid Security in the amount indicated in the **BDS**, which shall be not less than the percentage of the ABC in accordance with the schedule in the **BDS**.

15.2. The Bid and bid security shall be valid until **One Hundred Twenty (120) calendar days** from the date of opening of bids. Any bid not accompanied by an acceptable bid security shall be rejected by the Procuring Entity as non-responsive.

### 16. Sealing and Marking of Bids

Each Bidder shall submit Two (2) copies of the first and second components of its Bid, marked **Original** and photocopy. Only the original copy will be read and considered for the bid.

Any misplaced document outside of the **Original** copy will not be considered. The photocopy is ONLY FOR REFERENCE.

The Procuring Entity may request additional hard copies and/or electronic copies of the Bid. However, failure of the Bidders to comply with the said request shall not be a ground for disqualification.

If the Procuring Entity allows the submission of bids through online submission to the given website or any other electronic means, the Bidder shall submit an electronic copy of its Bid, which must be digitally signed. An electronic copy that cannot be opened or is corrupted shall be considered non-responsive and, thus, automatically disqualified.

Bidders must also comply with the Disclaimer and Data Privacy Notice specified in the **BDS**.

### 17. Deadline for Submission of Bids

The Bidders shall submit on the specified date and time and either at its physical address or through online submission as indicated in paragraph 7 of the **IB**.

## 18. Opening and Preliminary Examination of Bids

18.1. The BAC shall open the Bids in public at the time, on the date, and at the place specified in paragraph 9 of the **IB**. The Bidders' representatives who are present shall sign a register evidencing their attendance. In case videoconferencing, webcasting or other similar technologies will be used, attendance of participants shall likewise be recorded by the BAC Secretariat.

In case the Bids cannot be opened as scheduled due to justifiable reasons, the rescheduling requirements under Section 29 of the 2016 revised IRR of RA No. 9184 shall prevail.

18.2. The preliminary examination of Bids shall be governed by Section 30 of the 2016 revised IRR of RA No. 9184.

## 19. Detailed Evaluation and Comparison of Bids

19.1. The Procuring Entity's BAC shall immediately conduct a detailed evaluation of all Bids rated "passed" using non-discretionary pass/fail criteria. The BAC shall consider the conditions in the evaluation of Bids under Section 32.2 of 2016 revised IRR of RA No. 9184.

19.2. If the Project allows partial bids, all Bids and combinations of Bids as indicated in the **BDS** shall be received by the same deadline and opened and evaluated simultaneously so as to determine the Bid or combination of Bids offering the lowest calculated cost to the Procuring Entity. Bid Security as required by ITB Clause 15 shall be submitted for each contract (lot) separately.

19.3. In all cases, the NFCC computation pursuant to Section 23.4.2.6 of the 2016 revised IRR of RA No. 9184 must be sufficient for the total of the ABCs for all the lots participated in by the prospective Bidder.

## 20. Post Qualification

Within a non-extendible period of five (5) calendar days from receipt by the Bidder of the notice from the BAC that it submitted the Lowest Calculated Bid, the Bidder shall submit its latest income and business tax returns filed and paid through the BIR Electronic Filing and Payment System (eFPS), and other appropriate licenses and permits required by law and stated in the **BDS**.

## 21. Signing of the Contract

The documents required in Section 37.2 of the 2016 revised IRR of RA No. 9184 shall form part of the Contract. Additional Contract documents are indicated in the **BDS**.

## SECTION III

# BID DATA SHEET

**SECTION III - BID DATA SHEET**

| ITB Clause |  |
|------------|--|
| 5.2        | <p>For this purpose, contracts similar to the Project contracts and/or projects involving construction/rehabilitation of mooring facilities, piers, port terminal or loading/unloading jetty.</p> <p>The Single Largest Completed Contract (SLCC) as declared by the bidder shall be verified and validated to ascertain such completed contract. Hence, bidders must ensure access to sites of such projects/equipment to NPC representatives for verification and validation purposes during post-qualification process.</p> <p>It shall be a ground for disqualification, if verification and validation cannot be conducted for reasons attributable to the Bidder.</p>  |
| 7.1        | <p>Only a maximum of fifty percent (50%) of the Works may be subcontracted. All Subcontractors must be approved by NPC.</p>  |
| 10.1       | <p>The prospective bidder shall submit a valid and updated Certificate of PhilGEPs Registration under Platinum Membership (all pages including the Annex A of the said Certificate). <b>Non-compliance shall be a ground for disqualification.</b></p> <p>The list of on-going contracts (Form No. NPCSF-INFR-02) shall be supported by the following documents for each on-going contract to be submitted during Post-Qualification:</p> <ol style="list-style-type: none"> <li>1. Contract/Purchase Order and/or Notice of Award</li> <li>2. Certification coming from the project owner/client that the performance is satisfactory as of the bidding date.</li> </ol> <p>The bidder shall declare in this form all his on-going government and private contracts including contracts where the bidder (either as individual or as a Joint Venture) is a partner in a Joint Venture agreement other than his current joint venture where he is a partner. Non declaration will be a ground for disqualification of bid.</p> <p>The Statement of the bidder's Single Largest Completed Contract (SLCC) similar to the contract to be bid (Form No. NPCSF-INFR-03) shall be supported by the following documents to be submitted during Bid Opening:</p> <ol style="list-style-type: none"> <li>1. Contract/Purchase Order</li> <li>2. Owner's Certificate of Final Acceptance issued by the project owner other than the contractor or a final rating of at least Satisfactory in the Constructors Performance Evaluation System (CPES). In case of contracts with the private sector, an equivalent document (Ex. Official Receipt or Sales Invoice) shall be submitted.</li> </ol> |
| 10.3       | <p>The required License issued by the Philippine Contractors Accreditation Board (PCAB): License Category of at least <b>"CATEGORY D – GENERAL ENGINEERING"</b> and registration classification of at least <b>"SMALL B – PORT, HARBOR OR OFFSHORE ENGINEERING"</b> OR at least <b>"CATEGORY D – GENERAL BUILDING"</b> and registration classification of at least <b>"SMALL B – BUILDING AND INDUSTRIAL PLANT"</b></p>  |

|      |   |
|------|---|
| 10.4 | <p>The list of key personnel shall include the following minimum requirements:</p> <p><b>a. One (1) Project Engineer</b></p> <p>Registered Civil Engineer who had supervised at least a project similar in nature as to the type and cost of the proposed project within the last 10 years. Must have at least 5 years professional experience as Civil Engineer on similar project.</p> <p><b>b. One (1) Materials Engineer</b></p> <p>Registered Civil Engineer with valid accreditation from the Department of Public Works and Highways (DPWH) as Materials Engineer I</p> <p><b>c. One (1) Safety Officer 2</b></p> <p>Construction Safety Officer who has completed at least forty (40) hours of Construction Safety and Health Training (COSH) from Occupational Safety and Health Center (OSHC) or Safety Training Organizations (STOs) accredited by the Department of Labor and Employment (DOLE)</p> <p>The above key personnel must either be employed by the Bidder or contracted by the Bidder to be employed for the contract to be bid.</p> |
| 10.5 | <p>The list of construction equipment (owned or leased) shall include the following minimum requirements:</p> <p>a. Pile Driving Equipment (Barge Mounted) - 1 unit<br/>complete with 4.5 ton ram weight, 25 ton drop hammer and 40-50ton capacity crane</p> <p>b. Deck Barge (800 to 1000DWT) - 1 unit</p> <p>c. Welding Machine (500 Amp). - 1 unit</p> <p>d. Concrete Mixer (2-bagger) - 1 unit</p> <p>e. Bar Cutter (32mmΦ capable) - 1 unit</p> <p>f. Portable Generator - 1 unit</p> <p>g. Oxy-acetylene Cutting Outfit - 1 unit</p> <p>h. Concrete Vibrator - 1 unit</p> <p>i. Cargo Truck - 1 unit</p> <p>j. Service Vehicle - 1 unit</p>   |
| 10.6 | <p>Bidders shall also submit the following requirements in their first envelope, Eligibility and Technical Component of their bid:</p> <p>1. Complete eligibility documents of the proposed sub-contractor, if any</p>  |
| 10.7 | <p>Any single bidder/s who already procured/secured the bidding documents but want to avail the Joint Venture Agreement (JVA) shall inform the BAC in writing prior to the bid opening for records and documentation purposes.</p>  |
| 12   | <p>No further instructions</p>  |
| 15.1 | <p>The bid security shall be in the form of a Bid Securing Declaration or any of the following forms and amounts:</p> <p>1. The amount of not less than 2% of ABC, if bid security is in cash, cashier's/manager's check, bank draft/guarantee or irrevocable letter of credit;</p> <p>2. The amount of not less than 5% of ABC if bid security is in Surety Bond.</p>  |

|      |  |
|------|--|
| 16   | <p>All bid submissions and related correspondences are confidential and for viewing only by the intended recipient/s. Any unauthorized access to review, reproduce, or disseminate the information contained therein is strictly prohibited. The National Power Corporation (NAPOCOR) does not guarantee the security of any information electronically transmitted.</p> <p>Bid submissions and related correspondences may contain personal and sensitive personal information, and are subject to the Data Privacy Act of 2012, its implementing rules, regulations and issuances of the National Privacy Commission of the Philippines (“Privacy Laws”). By viewing, using, storing, sharing and disposing (collectively “Processing”), such bids submissions and correspondences, you agree to comply with the Privacy Laws. By responding to correspondence, you consent to the Processing by NAPOCOR of the Personal Data contained in your submission/reply in accordance with NAPOCOR’s Personal Data Privacy Policy which you can find at <a href="http://www.napocor.gov.ph">http://www.napocor.gov.ph</a>.</p> <p>To report any privacy issue, contact the Data Privacy Officer at <a href="mailto:dpo@napocor.gov.ph">dpo@napocor.gov.ph</a>.</p> <p>NAPOCOR is not liable for the proper and complete transmission of the information contained in bid submission/correspondences nor for any delay in its receipt.</p> |
| 19.2 | <p>Partial Bid is not allowed. The project is grouped in a single lot and the lot shall not be divided into sub-lots for the purpose of bidding, evaluation, and contract award.</p>   |
| 20   | <ol style="list-style-type: none"> <li>a. Class A – Eligibility Documents listed on the Annex A of Certificate of PhilGEPs Registration under Platinum Membership pursuant to Section 34.3 of the Revised IRR of R.A. 9184</li> <li>b. Contract/Purchase Order and/or Notice of Award for the contracts stated in the List of all Ongoing Government &amp; Private Contracts Including Contracts Awarded but not yet Started (NPCSF-INFR-02);</li> <li>c. Certification coming from the project owner/client that the performance is satisfactory as of the bidding date for all ongoing contracts stated in form NPCSF-INFR-02.</li> <li>d. Certificate of Employment, Bio Data and valid PRC License of the (professional) personnel (NPCSF-INFR-10a, NPCSF-INFR-11)</li> <li>e. Certificate of Employment, Bio Data and Accreditation or ID Card issued by DPWH as Materials Engineer (NPCSF-INFR-10a, NPCSF-INFR-11)</li> <li>f. Certificate of Employment, Bio Data and Construction Safety and Health Training Certificate from OSHC/STOs accredited by DOLE of the Safety Officer (NPCSF-INFR-10b, NPCSF-INFR-11)</li> <li>g. The licenses and permits relevant to the Project and the corresponding law requiring it as specified in the Technical Specifications, if any.</li> </ol>  |

|    |   |
|----|---|
| 21 | <p>The following documents shall form part of the contract:</p> <ol style="list-style-type: none"><li>1. Notice to Proceed</li><li>2. Construction schedule and S-curve</li><li>3. Manpower Schedule</li><li>4. Construction Methods</li><li>5. Equipment Utilization Schedule</li><li>6. Construction safety and health program of the contractor duly approved by the Bureau of Working Condition (BWC) of the Department of Labor and Employment (DOLE) or proof of submission to BWC</li><li>7. PERT/CPM.</li></ol> |
|----|---|



## SECTION IV

# GENERAL CONDITIONS OF CONTRACT

**SECTION IV – GENERAL CONDITIONS OF CONTRACT**

**TABLE OF CONTENTS**

| <u>CLAUSE NO.</u> | <u>TITLE</u>                               | <u>PAGE NO.</u> |
|-------------------|--|-----------------|
| 1.                | SCOPE OF CONTRACT .....                    | 1               |
| 2.                | SECTIONAL COMPLETION OF WORKS .....        | 1               |
| 3.                | POSSESSION OF SITE .....                   | 1               |
| 4.                | THE CONTRACTOR’S OBLIGATIONS .....         | 1               |
| 5.                | PERFORMANCE SECURITY .....                 | 2               |
| 6.                | SITE INVESTIGATION REPORTS .....           | 2               |
| 7.                | WARRANTY .....                             | 2               |
| 8.                | LIABILITY OF THE CONTRACTOR .....          | 2               |
| 9.                | TERMINATION FOR OTHER CAUSES.....          | 2               |
| 10.               | DAYWORKS.....                              | 2               |
| 11.               | PROGRAM OF WORK .....                      | 3               |
| 12.               | INSTRUCTIONS, INSPECTIONS AND AUDITS ..... | 3               |
| 13.               | ADVANCE PAYMENT .....                      | 3               |
| 14.               | PROGRESS PAYMENTS.....                     | 3               |
| 15.               | OPERATING AND MAINTENANCE MANUALS.....     | 3               |

## SECTION IV – GENERAL CONDITIONS OF CONTRACT

### 1. Scope of Contract

This Contract shall include all such items, although not specifically mentioned, that can be reasonably inferred as being required for its completion as if such items were expressly mentioned herein. All the provisions of RA No. 9184 and its 2016 revised IRR, including the Generic Procurement Manual, and associated issuances, constitute the primary source for the terms and conditions of the Contract, and thus, applicable in contract implementation. Herein clauses shall serve as the secondary source for the terms and conditions of the Contract.

This is without prejudice to Sections 74.1 and 74.2 of the 2016 revised IRR of RA No. 9184 allowing the GPPB to amend the IRR, which shall be applied to all procurement activities, the advertisement, posting, or invitation of which were issued after the effectivity of the said amendment.

### 2. Sectional Completion of Works

If sectional completion is specified in the **Special Conditions of Contract (SCC)**, references in the Conditions of Contract to the Works, the Completion Date, and the Intended Completion Date shall apply to any Section of the Works (other than references to the Completion Date and Intended Completion Date for the whole of the Works).

### 3. Possession of Site

3.1 The Procuring Entity shall give possession of all or parts of the Site to the Contractor based on the schedule of delivery indicated in the **SCC**, which corresponds to the execution of the Works. If the Contractor suffers delay or incurs cost from failure on the part of the Procuring Entity to give possession in accordance with the terms of this clause, the Procuring Entity's Representative shall give the Contractor a Contract Time Extension and certify such sum as fair to cover the cost incurred, which sum shall be paid by Procuring Entity.

3.2 If possession of a portion is not given by the above date, the Procuring Entity will be deemed to have delayed the start of the relevant activities. The resulting adjustments in contract time to address such delay may be addressed through contract extension provided under Annex "E" of the 2016 revised IRR of RA No. 9184.

### 4. The Contractor's Obligations

The Contractor shall employ the key personnel named in the Schedule of Key Personnel indicating their designation, in accordance with ITB Clause 10.3 and specified in the **BDS**, to carry out the supervision of the Works.

The Procuring Entity will approve any proposed replacement of key personnel only if their relevant qualifications and abilities are equal to or better than those of the personnel listed in the Schedule.

## 5. Performance Security

- 5.1. Within ten (10) calendar days from receipt of the Notice of Award from the Procuring Entity but in no case later than the signing of the contract by both parties, the successful Bidder shall furnish the performance security in any of the forms prescribed in Section 39 of the 2016 revised IRR.
- 5.2. The Contractor, by entering into the Contract with the Procuring Entity, acknowledges the right of the Procuring Entity to institute action pursuant to RA No. 3688 against any subcontractor be they an individual, firm, partnership, corporation, or association supplying the Contractor with labor, materials and/or equipment for the performance of this Contract.

## 6. Site Investigation Reports

The Contractor, in preparing the Bid, shall rely on any Site Investigation Reports referred to in the **SCC** supplemented by any information obtained by the Contractor.

## 7. Warranty

- 7.1. In case the Contractor fails to undertake the repair works under Section 62.2.2 of the 2016 revised IRR, the Procuring Entity shall forfeit its performance security, subject its property(ies) to attachment or garnishment proceedings, and perpetually disqualify it from participating in any public bidding. All payables of the GOP in his favor shall be offset to recover the costs.
- 7.2. The warranty against Structural Defects/Failures, except that occasioned-on force majeure, shall cover the period from the date of issuance of the Certificate of Final Acceptance by the Procuring Entity. Specific duration of the warranty is found in the **SCC**.

## 8. Liability of the Contractor

Subject to additional provisions, if any, set forth in the **SCC**, the Contractor's liability under this Contract shall be as provided by the laws of the Republic of the Philippines.

If the Contractor is a joint venture, all partners to the joint venture shall be jointly and severally liable to the Procuring Entity.

## 9. Termination for Other Causes

Contract termination shall be initiated in case it is determined *prima facie* by the Procuring Entity that the Contractor has engaged, before, or during the implementation of the contract, in unlawful deeds and behaviors relative to contract acquisition and implementation, such as, but not limited to corrupt, fraudulent, collusive, coercive, and obstructive practices as stated in **ITB** Clause 4.

## 10. Dayworks

Subject to the guidelines on Variation Order in Annex "E" of the 2016 revised IRR of RA No. 9184, and if applicable as indicated in the **SCC**, the Dayworks rates in the Contractor's Bid shall be used for small additional amounts of work only when the

Procuring Entity's Representative has given written instructions in advance for additional work to be paid for in that way.

## 11. Program of Work

- 11.1. The Contractor shall submit to the Procuring Entity's Representative for approval the said Program of Work showing the general methods, arrangements, order, and timing for all the activities in the Works. The submissions of the Program of Work are indicated in the **SCC**.
- 11.2. The Contractor shall submit to the Procuring Entity's Representative for approval an updated Program of Work at intervals no longer than the period stated in the **SCC**. If the Contractor does not submit an updated Program of Work within this period, the Procuring Entity's Representative may withhold the amount stated in the **SCC** from the next payment certificate and continue to withhold this amount until the next payment after the date on which the overdue Program of Work has been submitted.

## 12. Instructions, Inspections and Audits

The Contractor shall permit the GOP or the Procuring Entity to inspect the Contractor's accounts and records relating to the performance of the Contractor and to have them audited by auditors of the GOP or the Procuring Entity, as may be required.

## 13. Advance Payment

The Procuring Entity shall, upon a written request of the Contractor which shall be submitted as a Contract document, make an advance payment to the Contractor in an amount not exceeding fifteen percent (15%) of the total contract price, to be made in lump sum, or at the most two installments according to a schedule specified in the **SCC**, subject to the requirements in Annex "E" of the 2016 revised IRR of RA No. 9184.

## 14. Progress Payments

The Contractor may submit a request for payment for Work accomplished. Such requests for payment shall be verified and certified by the Procuring Entity's Representative/Project Engineer. Except as otherwise stipulated in the **SCC**, materials and equipment delivered on the site but not completely put in place shall not be included for payment.

## 15. Operating and Maintenance Manuals

- 15.1. If required, the Contractor will provide "as built" Drawings and/or operating and maintenance manuals as specified in the **SCC**.
- 15.2. If the Contractor does not provide the Drawings and/or manuals by the dates stated above, or they do not receive the Procuring Entity's Representative's approval, the Procuring Entity's Representative may withhold the amount stated in the **SCC** from payments due to the Contractor.

## SECTION V

# SPECIAL CONDITIONS OF CONTRACT

**SECTION V – SPECIAL CONDITIONS OF CONTRACT**

| GCC Clause |   |
|------------|---|
| 2          | Sectional completion is not specified.  |
| 3.1        | NPC shall give access to the Site for the Contractor to commence and proceed with the works on the start date. The access to the site referred herein shall not be exclusive to the Contractor but only to enable him to execute the Work.  |
| 4          | <p>It shall also be the obligation and responsibility of the Contractor to carry out the Works properly and in accordance with this Contract, including but not limited to the following conditions:</p> <p>a. The Contractor shall conduct the Works with due regard to safety and health in accordance with its Construction Safety and Health Program (CSHP) duly approved by the Department of Labor &amp; Employment (DOLE) and in compliance with the DOLE Department Order No. 13 – The Guidelines Governing Occupational Safety and Health in the Construction Industry.</p> <p>Failure to comply with the approved CSHP will be considered as non-compliance with the Contract and shall result to the imposition of Section 19, Violation and Penalties of the DOLE Department Order No. 13 and any appropriate sanctions such as, but not limited to:</p> <ol style="list-style-type: none"> <li>1. Suspend the work until the Contractor complies with the approved CSHP with the condition that the work resumption will not incur additional cost to the Corporation;</li> <li>2. Suspend payment of the portion of work under question;</li> <li>3. Correct the situation by employing 3<sup>rd</sup> party and charge all expenses incurred to the Contractor's collectibles/securities; and</li> <li>4. Report the condition to the Bureau of Working Conditions of the DOLE for their appropriate action.</li> </ol> <p>b. The Contractor shall be responsible for the strict compliance with the provision of the Philippine Laws affecting labor and operation of Work under the contract and shall be responsible for the payment of all indemnities arising out of any labor accident which may occur in the execution of the Works and for which he may be responsible under Republic Act 3428, as amended, known as the Workmen's Compensation Law.</p> <p>c. The Contractor is obliged to exercise due care so as not to endanger life and property in the vicinity of the Works where he operates in connection with this Contract. He shall be liable for all damages incurred in any manner by acts of negligence of his own, or his agents, employees, or workmen.</p> <p>d. It is the responsibility of the Contractor for the strict compliance with the requirements of the Philippine Clean Air Act of 1999 (R.A. 8749) and Philippine Clean Water Act of 2004 (R.A. 9275). The Contractor shall be liable for any damages/destructions to the environment</p> |

|          |  |
|----------|--|
|          | <p>including penalties that will be imposed by the Department of Environment and Natural Resources (DENR) arising from non-compliance of the requirements thereof.</p> <p>e. The Contractor shall be responsible for the strict compliance with the requirements of the Environmental Compliance Certificate (ECC) issued for this project (if any) and DENR Administrative Order No. 26. He shall be liable for any damages/destructions to the environment including penalties that will be imposed by the DENR arising from non-compliance thereof, in any manner by his acts or negligence, or by his agents, employees, or workmen in the execution of the Works. The Contractor may employ a Pollution Control Officer accredited with the DENR for the duration of the project, if so required by the DENR Administrative Order No. 26</p> <p>f. It shall be the Contractor's responsibility for the correctness, accuracy and quality of works. NPC's approval does not relieve his contractual obligation and responsibility under this contract.</p> <p>g. Payment of all forms of taxes, such as value added tax (VAT) including municipal licenses and permits, and others that may be imposed by the Philippine Government or any of its agencies and political subdivisions in connection with the Contract shall be for the account of the Contractor.</p> <p>h. In general, the Contractor is totally responsible for the execution of the Works and therefore, takes upon himself all the technical, legal and economic risks and all obligations which could arise therefrom or connected therewith. The overall responsibility of the Contractor includes the responsibility for actions or omissions of his own personnel as well as the personnel of the sub-contractors.</p> |
| <p>5</p> | <p>1. The following must be indicated in the performance bond to be posted by the Contractor:</p> <ul style="list-style-type: none"> <li>i. Company Name</li> <li>ii. Correct amount of the Bond</li> <li>iii. Contract/Purchase Order Reference Number</li> <li>iv. Purpose of the Bond:<br/>                     "To guarantee the faithful performance of the Principal's obligation to undertake <u>(Contract/Purchase Order Description)</u> in accordance with the terms and conditions of <u>(Contract No. &amp; Schedule/Purchase Order No.)</u> entered into by the parties."</li> </ul> <p>2. The bond shall remain valid and effective until the duration of the contract <u>(should be specific date reckoned from the contract effectivity)</u> plus sixty (60) days after NPC's acceptance of the last delivery/final acceptance of the project.</p> <p>3. In case of surety bond, any extension of the contract duration or delivery period granted to the CONTRACTOR shall be considered as given, and any modification of the contract shall be considered as authorized, as if with the expressed consent of the surety, provided that such extension or modifications falls within the effective period of the said surety bond. However, in the event that the extension of the contract duration or delivery schedule would be beyond the</p>   |



|     |  |
|-----|--|
|     | <p>effective period of the surety bond first posted, it shall be the sole obligation of the CONTRACTOR to post an acceptable Performance Security within ten (10) calendar days after the contract duration/delivery period extension has been granted by NPC.</p> <p>4. Other required conditions in addition to the standard policy terms issued by the Bonding Company:</p> <ul style="list-style-type: none"> <li>i. The bond is a penal bond, callable on demand and the entire amount thereof shall be forfeited in favor of the Obligee upon default of the Principal without the need to prove or to show grounds or reasons for demand for the sum specified therein;</li> <li>ii. The amount claimed by the Obligee under this bond shall be paid in full and shall never be subject to any adjustment by the Surety;</li> <li>iii. In case of claim, the Surety shall pay such claim within sixty (60) days from receipt by the Surety of the Obligee's notice of claim/demand letter notwithstanding any objection thereto by the Principal.</li> </ul>  |
| 6   | No site investigation report.  |
| 7.2 | <p>In case of permanent structures, such as buildings of types 4 and 5 as classified under the National Building Code of the Philippines and other structures made of steel, iron, or concrete which comply with relevant structural codes (e.g., DPWH Standard Specifications), such as, but not limited to, steel/concrete bridges, flyovers, aircraft movement areas, ports, dams, tunnels, filtration and treatment plants, sewerage systems, power plants, transmission and communication towers, railway system, and other similar permanent structures: Fifteen (15) years.</p> <p>In case of semi-permanent structures, such as buildings of types 1, 2, and 3 as classified under the National Building Code of the Philippines, concrete/asphalt roads, concrete river control, drainage, irrigation lined canals, river landing, deep wells, rock causeway, pedestrian overpass, and other similar semi-permanent structures: Five (5) years.</p> <p>In case of other structures, such as Bailey and wooden bridges, shallow wells, spring developments, and other similar structures: Two (2) years.</p> |
| 8.0 | <p><b>CORRECTION OF PUNCLIST ITEMS:</b></p> <p>After to the conduct of Test and Commissioning/Joint Final Inspection or upon the advice by the NPC, the Contractor/Supplier must correct any remaining works and work deficiencies identified in the punchlist issued for the project within one (1) month considering the approved remaining contract time.</p> <p>Failure to comply with this provision shall be grounds for non-issuance of Certificate of Satisfactory Performance which is a requirement for future bidding with the NPC. This, however, shall not preclude NPC's claim for liquidated damages, imposition of any other penalties and/or filing of blacklisting actions in accordance with the blacklisting guidelines issued by the Government Procurement Policy Board (GPPB).</p>  |

|      |   |
|------|---|
| 10   | No dayworks are applicable to the contract.   |
| 11.1 | The Contractor shall submit the Program of Work to the Procuring Entity's Representative within Ten (10) calendar days of delivery of the Notice of Award/Letter of Acceptance.   |
| 11.2 | <p>The period between Program of Work updates is Thirty (30) calendar days.</p> <p>The amount to be withheld for late submission of an updated Program of Work is One percent (1%) of contract amount.</p>  |
| 12   | <p>During contract implementation, the Procuring Entity shall conduct Constructors Performance Evaluation in accordance with Section 12, Annex E of the Revised Implementing Rules and Regulation of R.A. 9184 using the NPC Constructors Performance Evaluation System (CPES) Guidelines.</p> <p>CPES ratings shall be used for the following purposes: a) eligibility screening/post-qualification; b) awarding of contracts; c) project monitoring &amp; control; d) issuance of Certificate of Completion; and in adopting measures to further improve performance of contractors in the prosecution of government projects.</p> <p>Qualified Constructors Performance Evaluators (CPE) shall conduct project evaluation as follows:</p> <p>(a) During Construction - Except for those projects with a duration of 90 calendar days and below which may be subjected to at least one (1) visit, all projects shall be subjected to a minimum of two (2) evaluations to be performed by the CPE. The number of evaluations beyond the prescribed minimum shall be determined by the CPES-Implementing Unit based on the size, nature and complexity of the project and shall be subject to approval by the proper authorities within the agency. The first evaluation shall be performed when the project is at least thirty percent (30%) physically complete or as maybe required by the CPES-IU using the S-curve or other appropriate means to determine whether there is substantial work completed for evaluation.</p> <p>(b) Upon Completion - only one evaluation shall be performed by the CPE right after the Project Implementation Group reports one hundred percent (100%) completion of the project.</p> |
| 13   | The maximum amount of advance payment is fifteen percent (15%) of the Contract Price and paid in lump sum.  |
| 14   | No further instructions.  |
| 15.1 | The date by which "as built" drawings and operating and maintenance manuals are required is within thirty (30) calendar days after completion of contract.  |
| 15.2 | The amount to be withheld for failing to produce "as built" drawings and/or operating and maintenance manuals by the date required is Five percent (5%) of contract amount.   |

SECTION VI

**TECHNICAL SPECIFICATIONS**



SECTION VI

**TECHNICAL SPECIFICATIONS**

**PROJECT HIGHLIGHTS**

# SECTION VI – TECHNICAL SPECIFICATIONS

## PROJECT HIGHLIGHTS

### TABLE OF CONTENT

| <u>CLAUSE NO.</u> | <u>TITLE</u>   | <u>PAGE NO.</u> |
|-------------------|--|-----------------|
| <u>PH - 1.0</u>   | <u>GENERAL</u> .....                                 | <u>1</u>        |
| <u>PH - 2.0</u>   | <u>PROJECT LOCATION</u> .....                        | <u>1</u>        |
| <u>PH - 3.0</u>   | <u>SCOPE OF WORK</u> .....                           | <u>1</u>        |
| <u>PH - 4.0</u>   | <u>CONTRACT PERIOD</u> .....                         | <u>2</u>        |
| <u>PH - 5.0</u>   | <u>CONTRACTOR'S CLASSIFICATION</u> .....             | <u>2</u>        |
| <u>PH - 6.0</u>   | <u>MINIMUM REQUIRED KEY PERSONNEL</u> .....          | <u>2</u>        |
| <u>PH - 7.0</u>   | <u>MINIMUM REQUIRED CONSTRUCTION EQUIPMENT</u> ..... | <u>2</u>        |



## PROJECT HIGHLIGHTS

### PH-1.0 GENERAL

The proposed breasting dolphins are essential to replace the damaged breasting dolphin during the recent storm surge in the area. Power Barge 120 was moored at Balanacan Pier to augment the power supply needed in the province of Marinduque.

### PH-2.0 PROJECT LOCATION

The project is located near the existing Balanacan Pier at Mogpog, Marinduque.

### PH-3.0 SCOPE OF WORK

The works and services to be performed by the Contractor for this undertaking shall essentially consist of, but not limited to the following:

- a. Mobilization/establishment of Contractor's complete construction camp and other facilities;
- b. Furnishing, delivery, driving, splicing and cutting of pre-stressed concrete piles for the additional breasting structures/dolphins;
- c. Concreting of concrete pile caps;
- d. Furnishing and installation of used rubber tire fenders;
- e. Demobilization including clearing of site/demolition of Contractor's camp facilities.

### PH-4.0 CONTRACT PERIOD

The contractor shall complete the works within Sixty (60) calendar days. The total contract duration is inclusive of five (5) unworkable days considered unfavorable for the execution of work at site. The contract period shall be reckoned from the date of contract effectivity as specified in the Notice to Proceed.

### PH-5.0 CONTRACTOR'S CLASSIFICATION

The Contractor must have a valid Philippine Contractors Accreditation Board (PCAB) license of at least **Category D – General Engineering** and registration classification of at least **Small B – Port, Harbor or Offshore Engineering**.

The Contractor must have undertaken similar contracts and/or projects involving construction/rehabilitation of mooring facilities, piers, port terminal or loading/unloading jetty.

**PH-6.0 MINIMUM REQUIRED KEY PERSONNEL**

1. One (1) Project Engineer – Registered Civil Engineer who had supervised at least a project similar in nature as to the type and cost of the proposed project within the last ten (10) years. Must have at least 5 years professional experience as Civil Engineer on similar project.
2. One (1) Materials Engineer I – Registered Civil Engineer with valid accreditation from the Department of Public Works and Highways (DPWH) as Materials Engineer I.
3. One (1) Safety Officer 2 – Construction Safety Officer who has completed at least forty (40) hours of Construction Safety and Health Training (COSH) or Safety Training Organizations (STOs) accredited by the Department of Labor and Employment (DOLE).

Valid Professional Regulations Commission (PRC) license for professional personnel. Construction Safety and Health Training Certificate from OSCH/STOs accredited by DOLE for the Safety and Health Officer, certificate of accreditation including ID card issued by DPWH for Materials Engineer, shall be submitted and included as an attachment in the Standard Form NPCSF-INFR-09: List of Key Personnel Proposed to be Assigned to the Contract.

The above key personnel must either be employed by the Bidder or contracted by the Bidder to be employed for the contract to be bid.

**PH-7.0 MINIMUM REQUIRED CONSTRUCTION EQUIPMENT**

(Owned or Leased):

- |  |          |
|--|----------|
| a. Pile Driving Equipment (Barge Mounted)<br>complete with 4.5 ton ram weight, 25 ton drop<br>hammer and 40-50ton capacity crane | - 1 unit |
| b. Deck Barge (800 to 1000DWT)   | - 1 unit |
| c. Welding Machine (500 Amp).  | - 1 unit |
| d. Concrete Mixer (2-bagger)   | - 1 unit |
| e. Bar Cutter (32mm $\Phi$ capable)  | - 1 unit |
| f. Portable Generator  | - 1 unit |
| g. Oxy-acetylene Cutting Outfit  | - 1 unit |
| h. Concrete Vibrator   | - 1 unit |
| i. Cargo Truck   | - 1 unit |
| j. Service Vehicle   | - 1 unit |

SECTION VI

**TECHNICAL SPECIFICATIONS**

**CIVIL WORKS**





**SECTION VI – TECHNICAL SPECIFICATIONS**

**CIVIL WORKS**

**TABLE OF CONTENTS**

| <u>CLAUSE NO.</u> | <u>TITLE</u>                                     | <u>PAGE NO.</u> |
|-------------------|--|-----------------|
| <b>CW - 1.0</b>   | <b>GENERAL CONSTRUCTION FACILITIES.....</b>      | <b>1</b>        |
| CW -1.1.          | Scope .....                                      | 1               |
| CW -1.2.          | Moving-In.....                                   | 1               |
| CW -1.3.          | Contractor’s Camp Facilities .....               | 1               |
| CW -1.4.          | Water Supply .....                               | 1               |
| CW -1.5.          | Sewerage Disposal and Sanitation.....            | 1               |
| CW -1.6.          | Fire Protection.....                             | 2               |
| CW -1.7.          | Construction Power.....                          | 2               |
| CW -1.8.          | Camp Security .....                              | 2               |
| CW -1.9.          | Construction Material Storage.....               | 2               |
| CW -1.10.         | Removal of Camp and Construction Facilities..... | 2               |
| CW -1.11.         | Measurement and Payment .....                    | 3               |
| <b>CW - 2.0</b>   | <b>FALSEWORK AND FORMWORK.....</b>               | <b>4</b>        |
| CW -2.1.          | Scope .....                                      | 4               |
| CW -2.2.          | Material Requirement.....                        | 4               |
| CW -2.3.          | Construction Requirements.....                   | 4               |
| CW -2.4.          | Measurement and Payment .....                    | 6               |
| <b>CW - 3.0</b>   | <b>CONCRETE.....</b>                             | <b>7</b>        |
| CW -3.1.          | Scope .....                                      | 7               |
| CW -3.2.          | Class of Concrete .....                          | 7               |
| CW -3.3.          | Materials .....                                  | 7               |
| CW -3.4.          | Storage of Materials .....                       | 8               |
| CW -3.5.          | Concreting .....                                 | 9               |
| CW -3.6.          | Measurement and Payment .....                    | 10              |
| <b>CW - 4.0</b>   | <b>REINFORCING BAR .....</b>                     | <b>11</b>       |
| CW -4.1.          | Description.....                                 | 11              |
| CW -4.2.          | Material Requirement.....                        | 11              |
| CW -4.3.          | Construction Requirement.....                    | 11              |
| CW -4.4.          | Measurement and Payment .....                    | 14              |
| <b>CW - 5.0</b>   | <b>STRUCTURAL STEEL.....</b>                     | <b>16</b>       |
| CW -5.1.          | General.....                                     | 16              |
| CW -5.2.          | Materials .....                                  | 16              |
| CW -5.3.          | Execution.....                                   | 17              |



|                 |  |           |
|-----------------|--|-----------|
| CW -5.4.        | Measurement and Payment .....            | 19        |
| <b>CW - 6.0</b> | <b>MISCELLANEOUS STEEL.....</b>          | <b>20</b> |
| CW -6.1.        | Scope .....                              | 20        |
| CW -6.2.        | Shop Drawings.....                       | 20        |
| CW -6.3.        | Materials .....                          | 20        |
| CW -6.4.        | Workmanship.....                         | 20        |
| CW -6.5.        | Measurement and Payment .....            | 21        |
| <b>CW - 7.0</b> | <b>PRE-STRESSED CONCRETE PILES .....</b> | <b>22</b> |
| CW -7.1.        | Scope .....                              | 22        |
| CW -7.2.        | Material Requirements .....              | 22        |
| CW -7.3.        | Preparation for Driving .....            | 22        |
| CW -7.4.        | Test Piling.....                         | 22        |
| CW -7.5.        | Pile Driving.....                        | 23        |
| CW -7.6.        | Cutting of Piles.....                    | 24        |
| CW -7.7.        | Pile Formula.....                        | 24        |
| CW -7.8.        | Pile Records .....                       | 24        |
| CW -7.9.        | Measurement and Payment .....            | 24        |
| <b>CW - 8.0</b> | <b>FENDER SYSTEM .....</b>               | <b>26</b> |
| CW -8.1.        | General.....                             | 26        |
| CW -8.2.        | Materials .....                          | 26        |
| CW -8.3.        | Anchorage Fastening .....                | 26        |
| CW -8.4.        | Measurement and Payment .....            | 26        |



**SECTION VI – TECHNICAL SPECIFICATIONS****CIVIL WORKS****CW - 1.0 GENERAL CONSTRUCTION FACILITIES****CW -1.1. Scope**

This section covers the construction and/or maintenance of access roads, drainage systems and other appurtenant structures, moving-in of the Contractor's construction equipment, setting up of the Contractor's camp and the disposition of the Contractor's various facilities at the end of the Contract.

**CW -1.2. Moving-In**

The Contractor shall bring to the site all his necessary construction equipment and plant and install all stationary construction equipment and plant at location and in the manner approved by the NPC. The Contractor shall submit sufficient detailed plans showing the proposed location of such stationary equipment and plant and other pertinent data. No installation of such stationary equipment shall be undertaken unless the corresponding plans have been approved by the NPC.

**CW -1.3. Contractor's Camp Facilities**

The Contractor shall provide and grade his camp site, construct his camp, employee housing, warehouse, machine and repair shops, fuel storage tanks and provide such related facilities and sanitary conveniences that the Contractor deems necessary for maintaining health, peace and order in the camp and work areas. The areas that may be used by the Contractor within the plant site shall be designated by the NPC.

The Contractor shall provide, maintain and operate, under competent direction, such camps and facilities as are necessary for the housing, feeding and accommodation of his employees.

**CW -1.4. Water Supply**

The Contractor shall, at his own expense, be responsible for the supply, installation, operation and maintenance of a safe and adequate supply of drinking and domestic water. Whenever there is a possibility of contamination of the water supply for drinking and domestic purposes, chlorination or some other approved methods of sterilization shall be carried out. The installation and maintenance of these services shall be subject to the approval of the NPC.

**CW -1.5. Sewerage Disposal and Sanitation**

The Contractor shall, at his own expense, be responsible for the installation operation and maintenance of an adequate sewerage disposal and sanitation system and shall provide adequate toilet and wash-up facilities for his employees at his camp and in the areas where work is being carried out. The Contractor shall execute the work with due regard to adequate sanitary provisions and applicable codes and shall take all necessary steps to prevent the pollution of water in any spring, river, or other sources of water supply. All

toilets or wash-up facilities shall be subject to the prior and continuing approval of the NPC.

**CW -1.6. Fire Protection**

The Contractor shall observe all necessary precautions against fire, shall provide and maintain at his own expense, portable fire-fighting equipment he may deem necessary, and shall comply with all applicable laws of the Philippines relating thereto.

In the event of an uncontrollable fire occurring in the area of the Contractor's operation, the Contractor shall have to extinguish the fire immediately at his own expense, to the full extent of the manpower and equipment employed under the contract at the time of the fire.

The Contractor shall indemnify NPC against all liabilities, claims, damages and/or lawsuits arising thereto.

**CW -1.7. Construction Power**

The Contractor shall be responsible for providing his own electric power supply required for construction and erection/installation. If power is available from NPC and should the Contractor elect to utilize the NPC's power supply, he shall make an arrangement with NPC concerned group as to the billing rates and other requirements needed for direct connection to NPC.

**CW -1.8. Camp Security**

The Contractor shall provide his own security force to the extent that he deems necessary for maintaining peace and order in the camp and work areas and to safeguard materials and equipment. Nothing under the provisions of this paragraph shall relieve the Contractor from full responsibility for the maintenance of peace and order and protection of life and property in all areas where he operates.

**CW -1.9. Construction Material Storage**

The Contractor is required to put up warehouse(s) with capacities sufficient to store construction materials required in the work. The warehouse(s) shall be specifically for this contract, notwithstanding his other facilities in the site that may serve the purpose.

**CW -1.10. Removal of Camp and Construction Facilities**

After the completion of the work covered by the contract and prior to acceptance of the completed work, the entire camp facilities of the Contractor, including its water supply system, electric distribution system, quarters, warehouses, shops, dining halls, commissaries, temporary shed and other facilities therein shall be removed by the Contractor. The site shall be cleared and cleaned as directed by the NPC.

**CW -1.11. Measurement and Payment**

No separate measurement and payment will be made for the Contractor's Construction Facilities. The entire cost thereof shall be included in the various pay items in the Bill of Quantities.

**CW - 2.0 FALSEWORK AND FORMWORK****CW -2.1. Scope**

This work covers the supply, construction, erection and removal of falsework and formwork. Falsework shall provide the necessary rigidity, support the loads imposed and produce finished structure alignment, dimensions and grades indicated on the Drawings or as directed by NPC. Formwork shall be of sufficient strength with all necessary bracing, fasteners, etc. and in conformity with the specified requirements of applicable building code requirements for concrete framework, and National Structural Code of the Philippines.

**CW -2.2. Material Requirement**

Timber, lumber, steel pipes and plywood to be used for falsework and formwork shall be sound and shall comply with the requirements of these specifications. Use forms where a smooth form finish is required. Lumber shall be square-edged or tongue-and-groove boards, free or raised grain, knotholes and the other surfaces defects. Steel when used shall conform to the requirements of the ASTM A36. Steel form surfaces shall not contain irregularities, dents, or sags.

Forms shall be wood, plywood, or steel. Wood forms for surfaces exposed to view in the finished structure and requiring a smooth form finish, shall be plywood. For unexposed surfaces, undressed square-edge lumber may be used. Forms for surfaces requiring special finishes shall be plywood, or shall be lined with plywood, a non-absorptive, hard-pressed fiberboard, absorptive-type lining or other suitable material. Plywood, other than for lining, shall be concrete-form plywood free of raised grain, torn surfaces, worn edges, patches, or other surface defects, which would impair the texture of the concrete surface. Surfaces of steel forms shall be free from irregularities, dents, and sags.

**CW -2.3. Construction Requirements****CW-3.3.1 Falsework and Formwork Construction**

The materials used in the falsework shall be of the quantity and quality necessary to withstand the stresses imposed. The workmanship used in the falsework shall be of such quality that the falsework will support the loads imposed on it without excessive settlement.

Suitable jacks or wedges shall be used in connection with the falsework to set the forms to their required grade and to take up any excessive settlement in the falsework either before or during the placement of the concrete.

Should unanticipated events occur, including settlements that deviate more than  $\pm 20$  mm, which in the opinion of the Contractor would prevent obtaining a structure conforming to the requirements of the specification, the placement of the concrete shall be discontinued until corrective measures satisfactory to the NPC are provided. In the event satisfactory measures are not provided prior to initial set of the concrete in the affected area, the placing of concrete shall be discontinued at a location determined by NPC. All unacceptable concrete shall be removed.

Should unanticipated events occur, including settlements that deviate more than  $\pm 20$  mm, which in the opinion of the Contractor would cause non-conformity to the requirements of the specification, the placement of the concrete shall be discontinued until corrective measures satisfactory to the NPC are provided. In the event that corrective measures are not undertaken prior to initial set of the concrete in the affected area, the placing of concrete shall be discontinued at a location determined by NPC and all concrete already poured and placed shall be removed at the expense of the contractor.

Forms shall be mortar and watertight, true to the dimensions, lines and grades of the structure and with the sufficient strength, rigidity, shape and surface smoothness as to leave the finished works true to the dimensions shown on the drawings or required by NPC and with the surface finish as specified.

The inside surfaces of forms shall be cleaned of all dirt, mortar and foreign material. Forms, which will subsequently be removed, shall be thoroughly coated with a release agent or coating prior to its use. The release agent shall be commercial quality form oil or other approved coating which will permit the ready release of the forms and will not discolor the concrete.

Formwork for concrete placed underwater shall be watertight.

Forms shall be constructed so that the form surface of the concrete does not undulate excessively in any direction. Undulations exceeding either 2 mm or  $1/270$  of the center distance between studs, joints, form stiffeners', form fasteners, or wales will be considered to be excessive. Should any form of the forming system, even though previously approved for the use, produce a concrete surface with excessive undulations, its use shall be discontinued until modifications, satisfactory to NPC's Representative, have been made. Portions of concrete structures with surface undulations in excess of the limits herein stated may be rejected by the NPC.

Form fasteners consisting of forms bolts, clamps or other devices shall be used as necessary to prevent spreading of the forms during concrete placement. The use of ties consisting of twisted wire loops to hold the forms in position will not be permitted.

All formworks shall be provided with adequate clean-out openings to permit inspection and easy cleaning after all reinforcement has been placed. Where forms for continuous surfaces are placed in successive units, the forms shall be fitted over the completed surface to obtain accurate alignment of the surface and to prevent leakage of mortar. Panel forms shall be constructed so that they can be removed without damaging the concrete. All exposed joints, edges, and external corners shall be chamfered a minimum of 20 mm unless specified otherwise herein. Forms for heavy girders and similar members shall be constructed with a proper camber.

- **Coating:** Before placing the concrete, the contact surface of forms shall be coated with a non-staining mineral oil or suitable non-staining form coating compound or shall be given two coats of nitrocellulose lacquer, except as specified otherwise. Mineral oil shall not be used on forms for surfaces, which are to be painted. For surfaces not exposed to view in the finished structure, sheathing may be wetted thoroughly with clean water. All excess coating shall be removed by wiping with cloths. Reused forms shall have the contact surfaces cleaned thoroughly. Those that have previous coatings shall be

given an additional application of the same coating. Plaster waste molds shall be applied with two coats of the thin shellac or lacquer and coated with soft or thinned non-staining grease.

- **Tolerance and Variations:** The Contractor shall set and maintain concrete forms to ensure that, after removal of the forms and prior to patching and finishing, no portion of the concrete work will exceed any of the tolerances specified. Variations in floor levels shall be measured before removal of supporting shores. The Contractor shall be responsible for ensuring that tolerances specified shall not be exceeded. Except as otherwise specified herein, tolerances shall conform to ACI 347.

**CW-3.3.2 Removal of Falsework and Formwork**

Unless otherwise shown on the drawings or permitted by NPC, falsework supporting any span of structures shall not be released before fourteen (14) days after the last concrete has been placed on the span and adjacent adjoining span where falsework is to release.

Falsework supporting deck overhangs and deck slabs between girders shall not be released until seven (7) days after the deck concrete has been placed.

In addition to the above requirements, no falsework shall be released until the supported concrete has attained a compressive strength of at least eighty (80%) percent of the required 28-day strength.

Falsework and formwork shall not be removed without the permission of NPC, and such permission shall not relieve the Contractor of the responsibility for the safety of the work. Blocks and bracing shall be removed at the time the forms are removed and in no case shall any portion of the wood forms be left in the concrete.

Falsework removal for continuous structures shall be as directed by NPC or shall be temporarily supported such that the structure is gradually subjected to its working stresses. False work shall not be released in any span until the strength specified herein.

When concrete strength tests are used for removal of forms and supports, such removal shall be used as a minimum:

|  | Min. Time | Min.% Strength |
|--|-----------|----------------|
| Centering under girders and beams        | 14 days   | 80%            |
| Sides of beams and all vertical surfaces | 1 day     | 70%            |
| Floor Slabs                              | 14 days   | 80%            |

All debris and refuse resulting from work shall be removed and the site left in a neat and presentable condition.

**CW -2.4. Measurement and Payment**

No separate measurement for payment will be made for this item. The entire cost thereof shall be included in the various pay items in the Bill of Quantities.



SECTION VI-TECHNICAL SPECIFICATIONS

**CW - 3.0 CONCRETE**

**CW -3.1. Scope**

In accordance with the specifications contained in this section, the Contractor shall furnish all materials, labor, equipment and tools and perform all concreting works in accordance with the drawings, or as otherwise directed.

**CW -3.2. Class of Concrete**

Class of concrete or strength shall be as indicated on the drawings. Unless specified, the compressive strength of concrete shall conform to the requirement indicated on the provision of NSCP for Concrete and/or shall not be less than 20.7 MPa.

**CW -3.3. Materials**

**CW-3.3.1 Cement**

Cement for concrete works shall be furnished by the Contractor and shall conform to the requirements of the latest edition of the Standard Specifications for Portland Cement (ASTMC150).

Unless otherwise specified, cement shall be ordinary Portland cement. Type I for general construction which concrete is not in contact with soils or ground water and Type II for concrete in contact with soil or ground water.

Changing of brand or type of cement within the same structure will not be permitted unless with prior permission and approval obtained from the NPC.

**CW-3.3.2 Water**

Water for use in concrete shall be subject to the approval of the NPC. It shall not be salty and shall be reasonably clear and free from oil, acid, injurious alkali or vegetable matter.

**CW-3.3.3 Fine Aggregates**

Fine aggregates shall conform to the requirements of the latest edition of ASTM C33 and shall consist of hard, tough, durable and uncoated particles. Fine aggregates shall generally be rounded or cubical and reasonably free from flat or elongated particles. A thin, flat and elongated particle is defined as a particle having a maximum dimension greater than 5 times its maximum dimension.

Fine aggregate shall be well graded from coarse to fine, and gradation shall conform to the following requirements:

| <b>Sieve Designation U. S.<br/>(Standard Square Mesh)</b> | <b>Percentage by<br/>Weight Passing</b> |
|---|---|
| 9.5 mm (3/8")   | 100                                     |
| 4.76 mm (No. 4)   | 95-100                                  |
| 1.19 mm (No. 16)  | 50-85                                   |
| 0.297 mm (No. 50)   | 10-30                                   |
| 0.149 mm (No. 100)  | 2-10                                    |



SECTION VI-TECHNICAL SPECIFICATIONS

**CW3.3.4 Coarse Aggregates**

Coarse aggregates shall conform to the requirements of the latest edition of ASTM C33 and shall consist of hard, tough, durable and clean, uncoated particles. All foreign materials and dust shall be removed by processing. Coarse aggregates shall generally be rounded and reasonably free from thin, flat and elongated particles (as defined in CW-5.3.4 above) in all sizes.

Coarse aggregates shall be well graded from coarse to fine and gradation shall conform to the following requirements:

| <b>Sieve Designation<br/>U.S. Std. Square Mesh</b> | <b>Size Group<br/>Cumulative Percentage by Weight Passing</b> |                                  |                              |
|--|---|----------------------------------|------------------------------|
|  | <b>19.1 mm<br/>(3/4") max.</b>                                | <b>38.1 mm<br/>(1-1/2") max.</b> | <b>76.2 mm<br/>(3") max.</b> |
| 88.9 mm (3-1/2")                                   | -   | -                                | 100                          |
| 76.2 mm (3")                                       | -   | -                                | 90-100                       |
| 50.8 mm (2")                                       | -   | 100                              | 20-55                        |
| 38.1 mm (1-1/2")                                   | -   | 90-100                           | 0-15                         |
| 25.4 mm (1")                                       | 100   | 20-55                            | 0-5                          |
| 19.1 mm (3/4")                                     | 90-100  | 0-15                             | -                            |
| 9.5 mm (3/8")                                      | 20-55   | 0-5                              | -                            |
| 4.76 mm (No. 4)                                    | 0-15  | -                                | -                            |
| 2.38 mm (No. 8)                                    | 0-5   | -                                | -                            |

| <b>General Use</b>                                      | <b>Minimum General Aggregate Diameter</b> |
|---|---|
| Massive Concrete  | 76.2 mm (3")                              |
| Heavy walls and slabs<br>(0.75 m thick or more)         | 76.2 mm (3")                              |
| Walls, slabs, beams<br>(0.30 m to 0.75 m thick)         | 38.1 mm (1 1/2")                          |
| Thin walls, slabs, beam<br>(Less than 0.30 m thickness) | 19.1 mm (3/4")                            |

**CW -3.4. Storage of Materials**

**CW-3.4.1 Cement**

Cement shall be stored in a dry, weather-tight, and properly ventilated structure with adequate provisions for the prevention of absorption of moisture. All storage facilities shall be subject to the approval of the NPC and all cement shall be stored in such a manner and arrangement as to permit easy access for inspection and identification. Attention is directed to the requirement that delivery of cement to the site of work shall be so scheduled that no cement shall remain in storage longer than thirty (30) days after issue by the manufacturer. To preclude the undue aging of stored cement, the Contractor will not be permitted to use cement newly delivered to the job site whenever previously delivered cement is still available for use. Sacked cement shall not be stacked higher than fourteen sacks at any time during its storage.



**CW-3.4.2 Aggregates**

Fine and coarse aggregates shall be handled and stored separately in such a manner as to prevent the inclusion of foreign materials, segregation, or loss of fines.

**CW -3.5. Concreting****CW-3.5.1 General**

The written approval of the NPC shall be secured prior to any concreting work. All concrete shall be poured on the dry and cleaned surfaces.

**CW-3.5.2 Placing Reinforcement Embedded Items**

Before concrete placement/pouring, embedded reinforcing steel and other embedded items shall be in place in accordance with the construction drawings or as directed by the NPC. Placing of reinforcing steel shall be in accordance with the specifications specified under Reinforcing Bar.

**CW-3.5.3 Mixing Concrete**

Mixing of concrete shall conform to the requirements of ACI Code for Concrete Construction.

**CW-3.5.4 Placing Concrete**

Concrete shall be conveyed from mixers to the forms or to the place of deposit as rapidly as possible and by methods that will prevent segregation or loss of ingredients. There shall be no vertical drop greater than 1.5 meters except where suitable equipment like metal pipe or tremie is used. The pipe or tremie shall be kept full of concrete and its end shall be kept buried in the newly placed concrete. Chutes through which concrete is delivered to the structure in a thin, continuously exposed flow will not be permitted except for very limited or isolated sections of the work.

Earth surfaces, upon which concrete shall be placed, shall be cleaned, dry and thoroughly compacted before placing the concrete.

Rock surface, upon which concrete shall be placed, shall be thoroughly cleaned of loose or semi-detached or unsound rock particles. Before placing concrete, all surfaces shall be wetted thoroughly to keep them in a completely moist condition, after which leveling mortar of the same cement ratio as the concrete mix complete contact between concrete and the leveled surface.

**CW-3.5.5 Finishing Concrete**

After the concrete has been deposited, distributed and vibrated, the concrete shall be struck off and screened by mechanical means approved by the NPC. The finishing machine shall be of the screening and troweling type designed and operated both to strike off and to consolidate. Hand finishing may be employed when suitable finishing machines are not available. Finishing of concrete shall be done, as directed, to the satisfaction of the NPC.

All finished surfaces shall be tested with 3 meters straight edge and any variation of the surface from the desired crown or cross section shall be properly corrected.

**CW-3.5.6 Removal of Forms**

Forms shall be removed as soon as practicable in order to avoid delay in curing and to make possible earliest practicable repair of surface imperfections, but in no case shall they be removed without approval. Any needed repair or treatment shall be performed at once and shall be followed immediately by the specified curing. Forms shall be removed with care so as to avoid injury to the concrete and any concrete so damaged shall be repaired as directed.

**CW-3.5.7 Curing and Protection**

Concrete shall be cured for a period of not less than fourteen (14) consecutive days by keeping the surfaces of concrete continuously (not periodically) wet. Where tongue and groove forms were used and left in place of curing, they shall be kept wet at all times prevent opening at the joints and drying out of the concrete.

**CW -3.6. Measurement and Payment**

Measurement for payment for Concrete (except concrete which shall not be measured for separate payment) will be based on the volume of concrete placed and accepted within the neat lines of the structure as shown on the drawings or in accordance with the manner of measurement set forth in the various sections of the Technical Provisions. No deduction will be made for rounded or beveled edges or space occupied by the metal items 10 sq. cm. or less in cross section, embedded in concrete.

Payment will be made at the corresponding contract unit price for the various items of concrete shown in the Bill of Quantities. Payment shall cover all costs for furnishing all labor, materials, including equipment and tools required for concreting work. Payment shall also include care of water.

**CW - 4.0 REINFORCING BAR****CW -4.1. Description**

This work shall consist of furnishing, fabricating, and placing of steel reinforcement of the type, size, shape and grade required in accordance with these specifications and in conformity with the requirements shown on the Drawings or as directed by the NPC.

**CW -4.2. Material Requirement**

All material shall conform to the requirements hereinafter given. Certified test reports (mill test or other) shall be submitted to the NPC for all reinforcement steel used. These tests shall show the results of all chemical and physical tests made.

**CW-4.2.1 Bar Reinforcement**

Reinforcement bars for concrete shall be hot-rolled, weld able, deformed billet-steel bars conforming to the requirements specified in ASTM A615 and PNS 49 unless shown on the Drawings or as required by the NPC. The use of the cold twisted bars is not permitted. If not otherwise shown on the drawings, the deformed reinforcement steel shall be Grade 60 (minimum yield strength of 410 MPa) for 16 mm  $\Phi$  and bigger bars and Grade 40 (minimum yield strength of 275 MPa) for 12 mm  $\Phi$  and smaller bars. Bar reinforcement shall be shipped in standard bundles, tagged and marked in accordance with the Code of Standard Practice of the Concrete Reinforcement Steel Institute.

**CW-4.2.2 Sampling**

The NPC's Representative will sample reinforcement bars at the source of supply or at the point of distribution, and the Contractor shall notify the NPC in sufficient time advance to permit sampling and testing before shipment is made. Three (3) samples from each size shall be taken at random representing five (5) tons or fraction thereof of each size.

**CW -4.3. Construction Requirement****CW-4.3.1 Order List for Bent Bars**

Before materials are ordered, the Contractor shall furnish all order lists and bending diagrams for the approval of the NPC. The approval of order lists and bending diagrams by the NPC shall in no way relieve the Contractor of responsibility for the correctness of such lists and such lists and diagrams. Any expenses incident to the revisions of materials furnished in accordance with such lists and diagrams to make them comply with the drawings shall be borne by the Contractor.

Shop Drawings for Reinforcing Steel (ACI 315): Indicate bending diagrams, assembly diagrams, splicing and laps of bars, shapes, dimensions and details of bar reinforcing, accessories and concrete cover. Do not scale dimensions from structural drawings to determine lengths of reinforcing steel.

SECTION VI-TECHNICAL SPECIFICATIONS

CW-4.3.2 Fabrication

Bent bar reinforcement shall be cold bent as shown on the drawings or as required by the NPC. Bars shall be bent around circular pin having the following diameters (D) in relation to the diameter of the bar (d):

|                              |       |
|------------------------------|-------|
| Bars 6mmΦ to 20mmΦ inclusive | D=6d  |
| Bars 25mmΦ and 28mmΦ         | D=8d  |
| Bars 32mmΦ and greater       | D=10d |

Bends and hooks in stirrups and lateral ties may be bent to the diameter of the principal bar enclosed therein.

CW-4.3.3 Protection of Material

Steel reinforcement shall be protected at all times from injury. When placed in the work, it shall be free from dirt, detrimental scale, paint, oil or other foreign matter. However, when steel has on its surface easily removable and detrimental rust, loose scale or dust, it shall be cleaned by a satisfactory method, approved by the NPC.

Store reinforcement of the different sizes in racks raised above the ground with accurate identification. Protect reinforcing steel from contaminants such as grease, oil and dirt.

CW-4.3.4 Placing and Fastening Reinforcement & Miscellaneous Material (ACI 301)

All reinforcement bars, stirrups, hanger bars, wire fabric, spirals and other reinforcing materials shall be provided as indicated in the drawing or required by the specification, together with all necessary wire ties, chairs, screws, supports, and other devices necessary to install and secure the reinforcement properly. All reinforcement, when placed, shall be free from rust, scale, oil, grease, clay, and other coatings, and foreign substances that would reduce or destroy the bond. Rusting of reinforcement shall not reduce the effective cross sectional area of the reinforcement to the extent that the strength is reduced beyond specified values. Heavy, thick rust or loose, flaky rust shall be removed by rubbing with burlap or other approved method, prior to placing. Reinforcement that has bends not shown on the project drawings or on approved shop drawings, or is reduced in section by rusting such that its weight is not within permissible ASTM tolerances, shall not be used. All reinforcement shall be supported and wired together to prevent displacement by construction loads or by the placing of concrete. Unless directed otherwise by the NPC, reinforcement shall not be bent after being partially embedded in hardened concrete. Detailing of reinforcing shall conform to ACI 315. Where cover over reinforcing steel is not specified or indicated, it shall be in accordance with ACI 318

All steel reinforcement shall be accurately placed in position shown on the drawings or as required by the NPC and firmly held there during the placing and setting of the concrete. Bars shall be tied at all intersections except where spacing is less than 30 mm in each direction, when alternate intersections shall be tied. Ties shall fasten on the inside.

Distance from the forms shall be maintained by means of stays, blocks, hangers or other approved supports. Blocks for holding reinforcement from contact with the forms shall be pre-cast mortar blocks of approved shape and



dimensions or approved chairs. Layers of bars shall, be separated by pre-cast mortar blocks or by other equally suitable devices. The use of pebbles, pieces of broken stone or brick, metal pipe and wooden blocks or metal chairs shall not be permitted. Unless otherwise shown on the Drawings or required by the NPC, the minimum distance between bars shall be 40mm. Reinforcement in any member shall be placed and then inspected and approved by the NPC before the placing of concrete commences. Bundled bars shall be tied together at not more than 1.80 meters intervals.

Reinforcement shall be placed accurately and secured. It shall be supported by suitable chairs and spaces or by metal hangers. On the ground, and where otherwise subject to corrosion, concrete or other suitable non-corrodible material shall be used for supporting reinforcement. Where the concrete surface will be exposed to the weather in the finished structure or where rust would impair the appearance or finish of the structure, all reinforcement supports, within specified concrete cover, shall be galvanized or made of a suitable non-corrodible material.

All placement or movement of reinforcing steel after placement, to positions other than indicated or specified, shall be subject to the approval of the NPC.

Concrete protection for reinforcement shall be as indicated, or if not indicated, in accordance with ACI 318.

The minimum concrete cover for reinforcement specified in the bid documents shall takes precedence over all permissible reinforcement placement variations; nothing in the variations listed below is to be constructed as permitting violation or compromise thereof:

|   |                  |
|---|------------------|
| a. Height of bottom bars                    | ±6mm above form  |
| b. Lengthwise positioning                   | ±50mm of bars    |
| c. Spacing bars in walls<br>and solid slabs | ±25mm            |
| d. Spacing bars in<br>beams and footings    | ±6mm             |
| e. Height of top bars                       | ±6mm             |
| f. Stirrup spacing                          |                  |
| (1) For any one stirrup                     | ±25mm            |
| (2) For over-all group                      | ±25mm of stirrup |

Anchors and bolts; including but not limited to those for the machine and equipment bases: frames or edgings, hangers and inserts, door bucks, pipe supports, pipe sleeves, pipe passing through walls, metal ties, conduits, flashing reflects, drains and all other materials in connection with the concrete construction shall, where practicable be placed and secured in position when the concrete is placed. Anchor bolts for machines shall be set to templates, shall be plumbed carefully and checked for location and elevation with an instrument, and shall be held in position rigidly to prevent displacement while concrete is being placed.

#### CW-4.3.5 Splicing

Splicing of reinforcement shall be in accordance with ACI 318, except as indicated otherwise or modified herein. Where splices in addition to those indicated on the drawings are necessary, they shall be approved by the NPC prior to their use. Splices shall not be made in beams, girders, and slabs at

points of maximum stress. Butt splicing shall preferably be used over lapping for bar sizes larger than 32mmΦ. Splices to be welded shall conform to AWS D1.4; certification of weld ability of the reinforcement by the manufacturer, shall be submitted to the NPC. If the Contractor elects to use butt splicing of reinforcing, he shall submit complete details of the process to be used by the NPC. If the butt splices are used, the Contractor shall ensure that the splice meets the requirements specified herein by performing at least three splices which shall be submitted for tests to a testing laboratory that has been approved for such testing by the NPC. The cost of these shall be borne by the Contractor.

All reinforcement shall be furnished in the full lengths indicated on the Drawings. Splicing of bars, except where shown on the Drawings will not be permitted without the written approval of the NPC. Splices shall be staggered as far as possible and with a minimum separation of not less than 40 bar diameters. Not more than one-third of the bars may be spliced in the same cross section, except where shown on the Drawings.

Unless otherwise shown on the Drawings, bars shall be lapped a minimum distance of:

| Splice Type | Grade 40 Min.Lap | But Not Less Than |
|-------------|------------------|-------------------|
| Tension     | 24d              | 300mm             |
| Compression | 20d              | 300mm             |

Where d is the diameter of the bar. In lapped splices, the bars shall be placed in contact and wired together. Lapped splices will not be permitted at locations where the concrete section is insufficient to provide a minimum clear distance of one and one-third the maximum size of coarse aggregate between the splice and the nearest adjacent bar. Welding of reinforcing steel shall only be done if detailed on the Drawings or if authorized by the NPC in writing. Spiral reinforcement shall be spliced by lapping at least one and half (1 1/2) turns or by butt-welding unless otherwise shown on the drawings.

**CW -4.4. Measurement and Payment**

The quantity to be paid for shall be the calculated theoretical number of kilograms of reinforcement steel bars as determined from the net length of the steel shown on the drawings, incorporated in the concrete and accepted.

The weight of deformed bars will be computed from the theoretical weight of the same nominal size as shown in the following tabulation:

| Designation | Size (mm) | Weight (kg/m) |
|-------------|-----------|---------------|
| #2          | 6         | 0.222         |
| #3          | 10        | 0.616         |
| #4          | 12        | 0.888         |
| #5          | 16        | 1.579         |
| #6          | 20        | 2.468         |
| #8          | 25        | 3.854         |
| #9          | 28        | 4.833         |
| #10         | 32        | 6.313         |
| #11         | 36        | 7.991         |





SECTION VI-TECHNICAL SPECIFICATIONS

LuzP23Z1586Sc

Clips, ties, separators and other and related materials used for positioning and fastening the reinforcement in place as required by the NPC shall not be included in the weight-calculated payment under this item. If bars are substituted upon the Contractor's request and as result, more steel is used than specified; only the amount specified shall be included.

When laps are made for splices, other than those shown on the drawings or required by the NPC and for the convenience of the Contractor, the extra steel shall not be measured nor paid for.

The accepted quantity shall be paid at the corresponding unit price for the item, Reinforcing Steel as shown in the Bill of Quantities which price and payment shall be made in full compensation for furnishing materials, labor, equipment and incidentals necessary to complete this item.



**CW - 5.0 STRUCTURAL STEEL****CW -5.1. General**

This section covers the fabrication, erection, and shop painting of structural steel in accordance with the AISC "Manual of Steel Construction" referred to herein. In the AISC "Manual of Steel Construction" referred to herein, the Specification for Design, Fabrication, and Erection of Structural Steel for Buildings," and "Structural Joints using A325 or A490 Bolts" shall be considered a part thereto.

**CW-5.1.1 Submittals**

**Shop Drawings:** Submit shop drawings of all structural steel in five (5) copies for approval prior to fabrication of structural steel. Include complete information necessary for the fabrication and erection of the component parts of the structure including the location, type and size of all bolts and welds, member sizes and lengths, camber & connector details, blocks, copes, and cuts. Include all welds by standard welding symbols.

**Erection Plan:** Submit descriptive data to illustrate the structure steel erection procedure including the sequence of erection and temporary shoring and bracing, and written description of the detailed sequence of all welding, including each welding procedure to be performed.

**Certificates of Conformance:**

Submit certificates of conformance for the following:

- Bolts, Nuts and Washers
- Welding Electrodes and Rods
- Paint
- Steel
- Certified Test Reports

**Structural Steel:**

Chemical analysis and tensile strength test required by ASTM, ASTM A53

**High Strength Bolts and Nuts:**

Chemical analysis, tensile strength and hardness test required by ASTM A325.

**CW-5.1.2 Delivery and Storage:**

Handle, ship, and store material in a manner that will prevent distortion or other damage. Store material in a clean and properly drained location and out of contact with the ground. Replace all damaged material with new material or repair the damaged material in an approved manner at no additional cost to the NPC.

**CW -5.2. Materials**

All materials shall be of the best quality of their kind, well graded and within the allowable distortions, however, they shall be free from flakes, corrosion, scale or fragments that could reduce the resistance and durability or injure the external appearance.

Except as modified herein, blast clean surfaces in accordance with SSPC SP6. Wash clean surfaces that become contaminated with rust, dirt, oil, grease or other contaminants with solvents until thoroughly clean. Ensure that steel to be embedded in concrete and surfaces when assembled, are free from rust, grease, dirt and other foreign matter.

**CW-5.2.1 Steel**

Materials shall conform to the respective specifications specified herein. Materials not otherwise specified herein shall conform to the AISC "manual of Steel Construction".

Structural Steel:       ASTM A36  
Steel Pipe:             ASTM A53, Type E or S, Grade B, ASTM A501.  
Steel W-Shape Piles  
(Soldier Piles):        ASTM A328

**CW-5.2.2 Bolts, Nuts and Washers:**

All bolts, nuts and washers shall be of hot-dip galvanized steel.

Bolts:                    ASTM A307, Grade C or ASTM A36 for Anchor Bolts;  
                              ASTM A325 for Fastening Bolts.

Nuts:                    ASTM A563, Grade A, heavy hex style, except nuts less than  
                              38mm may be provided in hex style.

Washers:                ANSI B18.22.1, Type B.

**CW-5.2.3 Accessories:**

Welding Electrodes  
and Rods:               Steel structural members shall use E70XX electrodes.

Non-shrink Grout;     ASTM C827; non-metallic.

**CW -5.3. Execution**

**CW-5.3.1 Fabrication:**

Fabricate in accordance with the applicable provisions of the Specification for the Design, Fabrication, and Erection of Structural Steel for Buildings as set forth in the AISC "Manual of Steel Construction".

**CW-5.3.2 Welding of Structural Steelwork:**

All welding works shall be as indicated on the drawings and shall conform to AWS D1.1 - 77 "Structural Welding Code". Unless specified on the drawings, fillet welds shall be a minimum of 5 mm (3/16") and welding electrodes shall be with a tensile strength of 485 MPa.

All welding works shall be executed by the AWS D1.1 qualified welders, welding operators and trackers, whose workmanship shall be subject to the approval of NPC.

**CW-5.3.3 Shop painting:**

Except as otherwise specified, shop prime surfaces of all structural steel, except steel to be embedded in concrete or mortar. Surfaces to be welded shall not be coated within 12 mm from the specified top of the weld prior to welding. Insure that the surfaces are thoroughly dry and clean when the paint is applied. Do not paint on wet weather except under cover. Do not apply paint to steel, which is at a temperature that will cause blistering or porosity, or will otherwise be detrimental to the life of the paint. Apply paint in a workmanlike manner, and coat all joints and crevices thoroughly. Prior to assembly, paint all surfaces that will be concealed or inaccessible after assembly.

Shop prime coat surfaces as soon as possible after cleaning. Apply one coat of inorganic zinc to a minimum dry film thickness of 100 microns.

- **Field painting:** When the erection work is complete, the heads of field bolts, all welds and any surface from which the shop coat of paint has become worn off or has otherwise become defective, shall be cleaned and thoroughly covered with one coat of shop coat paint. When the paint applied for touching up bolt heads and abraded surfaces has become thoroughly dry, apply two field coats of marine epoxy paint subject to the approval of NPC.
- **Marking:** Prior to erection, members shall be provided with a painted erection mark. In addition, connecting parts assembled in the shop for remaining holes in field connections shall be matched marked with scratch and notch marks. Do not locate erection markings on areas to be welded. Do not locate erection markings in areas that will decrease member strength or cause stress concentrations.

**CW-5.3.4 Erection:**

Except as modified herein, erect steel in accordance with the AISC "Manual of Steel Construction". Where parts cannot be assembled or fitted properly as a result of errors in fabrication or of deformation due to handling or transportation, report such condition immediately to the NPC's Representative and obtain approval there from for the methods of correction for straightening, including members of steel conforming to ASTM A514.

Drain Steel work properly; fill pockets in structures exposed to the weather with an approved waterproof material.

Provide safety belts and lines for workmen aloft on high structures unless safe working platforms or safety nets are provided.

When calibrated wrenches are used for tightening bolts, calibrate them at least one each working day using not less than three typical bolts of each diameter. Do not use impact torque wrenches to tighten anchor bolts set in concrete.

**Connections:** Connections shall be executed as shown on drawing. In case, connections are not detailed, it shall be designed in accordance with AISC "Manual of Steel Construction". Build connections into the existing work. Punch, sub-punch and ream, or drill bolt holes.

Tolerances: Structural steel shall be furnished and installed to the lines and levels as shown on the drawings.

Any structure that does not conform shall be repaired, removed and/or erected anew by the Contractor at no additional cost to NPC.

Tolerances on structural steel shall be in accordance with the "Code of Standard Practice" of the AISC "Manual of Steel Construction".

#### CW-5.3.5 Tests and Inspections:

##### Visual Inspection of Welding:

After the welding is completed, hand or power wires brush welds, thoroughly clean them before the inspector makes the check inspection. Inspect welds with magnifiers under strong, adequate light for surface cracking, porosity, and slag inclusions; excessive roughness; unfilled craters; gas pockets; undercuts; overlaps; size and insufficient throat and concavity. Inspect the preparation of groove welds for adequate throat opening and for snug positioning of backup bars.

##### Non-Destructive Testing:

In accordance with AWS D1.1 Twenty-five percent (25%) of the total number of joints, as selected by the NPC, shall be tested. If more than 20 percent of welds contain defects identified by testing, then all welds shall be tested by radiographic or ultrasonic testing, and to be approved by the NPC. When all welds made are required to be tested, magnetic particle testing shall be used only in areas inaccessible to either radiographic or ultrasonic testing. Retest defective areas after repair.

#### CW -5.4. Measurement and Payment

Measurement for payment for structural steel shall be based on the total kilograms of structural steel placed and accepted.

Payment will be made at the contract unit price for the item Structural Steel in the Bill of Quantities, which payment shall constitute full compensation for furnishing all labor and equipment necessary to complete the item.

**CW - 6.0 MISCELLANEOUS STEEL**

**CW -6.1. Scope**

This sections covers performance of all work in connection with miscellaneous steel work including but not limited to handrails, ladders, and hatch opening, pit and trench covers, embedded plates, conduit, pipe items, all complete with anchoring devices, bolts and fastenings. The Contractor shall furnish materials, fabricate, assemble, install and paint all miscellaneous steel works.

**CW -6.2. Shop Drawings**

Complete shop and erection drawings of all miscellaneous steelworks showing sizes, methods of assembly, hardwares and anchorage details, shall be furnished by the Contractor subject to approval of the NPC.

**CW -6.3. Materials**

The materials furnished by the Contractor under this section shall conform to the following standards:

| <u>Materials</u>   | <u>Standard</u>  |
|--|--|
| Structural Steel (columns, girders, beams, bracing, ladders, hatch opening, pit and trench cover, embedded plates, etc.) | ASTM A36" Specification for Structural Steel" or equivalent Standard.  |
| Black Pipe (pipe railings and pipe for drains)   | ASTM 120"Specifications for Black and Hot-Dipped Zinc Coated and Welded and Seamless Steel Pipe for Ordinary Uses" |
| Steel Grating  | ASTM A36 or equivalent   |
| Steel Checkered Plate (Cable Trench Cover)   | ASTM A36 or equivalent   |

Material not specifically designated above shall comply, as far as practicable, with the latest specifications of the ASTM or other approved standards.

The names of the manufacturers of material shall be furnished for approval.

**CW -6.4. Workmanship**

a. General

All works shall be executed by a technician skilled in the work and all workmanship and material shall be subject to the approval of the NPC. All miscellaneous steelwork shall be carefully and accurately assembled in the most satisfactory manner to carry out the design shown on the drawings. All joints shall be milled or machined as may be necessary to secure, close and perfect connections. Items shall be carefully

assembled and the component parts shall be well secured together by welding or with screws, bolts and rivets, and concealed as far as possible. Member shall not be over stressed during the process or erection and hammering that will injure or distort the members shall not be permitted. Built-up works shall be assembled completely at the shop, accurately finished and section match-marked for field erection.

The Contractor shall furnish all welding rods required for field welds and all anchors, temporary bracing, tie rods, shims, erection bolts, and other miscellaneous materials required during erection.

b. Embedded Steel Plate

The Contractor shall furnish, fabricate and install all embedded steel plates necessary for pipes, cable trays, duct equipment and installations and supports in accordance with the approved shop drawings or as directed by the NPC. All embedded steel plates shall be accurately set in place at the time when concrete is placed.

c. Steel Checkered Plates

The contractor shall place or install the steel checkered plates in accordance with the approved construction drawings and specifications, or as directed by the NPCs. Fabricated steel checkered plates of ASTM Standards including reinforcing angles, plates, supporting members and anchoring devices shall be furnished by the Contractor.

d. Welding

The welding shall be in accordance with the Code of Arc-end Gas Welding in Building Construction, as formulated by the American Welding Society.

All welding shall be continuous along entire line of contract except where tack welding is permitted. All exposed welds shall be ground smooth.

e. Painting

Painting is included in the applicable bid prices for the various items in the Bill of Quantities.

### **CW -6.5. Measurement and Payment**

Measurement for payment will be based on the total kilogram of materials placed or installed in accordance with the drawings or as directed by the NPC.

Payment will be made at the unit bid price for the item, Miscellaneous Steel, in the Bill of Quantities. The unit price shall include all costs of fabrications, supply of reinforcing materials including supports, handling, placing, painting and other incidentals necessary for the completion of work.

**CW - 7.0 PRE-STRESSED CONCRETE PILES****CW -7.1. Scope**

This section shall consist of the furnishing, driving and cutting of pre-stressed concrete piles in accordance with these specifications and in conformity with Drawings and/or as directed by NPC.

The sizes, reinforcement and compressive strength of pre-stressed piles shall be as shown on the Drawings.

**CW -7.2. Material Requirements**

- a. Pre-stressed piles shall be made in accordance with the Drawings, and reinforcement shall be placed accurately and secured rigidly in such manner as to insure its proper location in the completed pile. The concrete cover as measured from the outside face of ties or spirals shall not be less than 20mm.
- b. The piles shall be cast separately or, if alternate piles are cast in a tier, the intermediate piles shall not be cast until 4 days after the adjacent piles have been poured. Piles cast in tiers shall be separated by-tar paper or other suitable separating material. The concrete in each pile shall be placed continuously. The completed piles shall be free from stone pockets, porous spots, or other defects, and forms shall be straight and true and built of metal, plywood, or dressed lumber.
- c. Piles shall be cured in accordance with the generally accepted standards.
- d. Piles shall not be moved until the tests indicate a compressive strength of 80% of the design 28-day compressive strength is attained and they shall not be driven until the tests indicate a compressive strength at least equal to the design 28-day compressive strength.
- e. When concrete piles are lifted or moved, they shall be supported at the points on the Drawings, or if not shown, as instructed by NPC.

**CW -7.3. Preparation for Driving**

Piles shall not be driven until after all preparatory works are completed. Pile templates, if to be constructed, shall be rigidly secured to ensure that piles are driven to their accurate locations. The heads of piles shall be cut squarely and a driving cap shall be provided to hold the axis of the pile in line with the axis of the hammer.

Full-length piles shall be used. Splicing of piles shall not be allowed if test piles showed that the required pile length is less than 30 m. In case splicing is permitted on exceptional circumstance and when required length exceeds 30 m, the method of splicing shall be subject to approval of NPC.

**CW -7.4. Test Piling**

The contractor shall first cast or order 1 test pile as indicated in the plan and of greater length than that assumed in the design to provide for any variation in soil condition but ranges from 20 to 30meters. The test pile shall be driven to refusal or as directed by NPC. Since a test piles will become part of the



completed structures, its location will be as indicated in the drawings or as directed by NPC. The results of driving the test pile shall be submitted immediately to NPC for the determination of the actual length of the remaining piles to be ordered, furnished and delivered at the site. The actual pile lengths based from the result of the test pile shall be the basis for payment. However, pertinent provisions regarding penetration depths and the specified bearing values shall not be disregarded.

#### **CW -7.5. Pile Driving**

- a. All piles shall be driven accurately as shown on the drawings. Each pile, after driving shall be within 150 mm from the theoretical location underneath the pile cap or underneath the superstructure in case of pile bents. Inclination of vertical piles shall be within 1/75. Tolerance of level of pile shall be within 5 cm. The axis can deviate by up to 10% of the pile length for raking piles, provided the pile axis is driven straight.
- b. Piles shall be driven to the minimum depths shown on the drawings or deeper if necessary to achieve the required final set.
- c. All pile driving equipment is subject to the approval of NPC. The Contractor is responsible for sufficient weight and efficiency of the hammer to drive the piles down to the required depth and bearing capacity. Diesel hammer shall be used.
- d. Piles shall be supported in line and position with leads and shall be constructed in such a manner as to afford freedom of movement of the hammer, and shall be held in position by guys or steel braces to insure rigid lateral support to the pile during driving. The leads shall be of sufficient length to make the use of a follower unnecessary. The driving of pile with follower shall be avoided if practicable and shall be done only under written permission from the NPC.
- e. The method used in driving piles shall not subject them to excessive and undue abuse producing crushing and spalling of concrete. Manipulation of piles to force them into proper position will not be permitted.
- f. The pile tops shall be protected by driving heads, caps or cushions in accordance with the recommendations of the manufacturer of pile hammer. The driving head shall be provided to maintain the axis of the pile in line with the axis of the hammer and provide a driving surface normal to the pile.
- g. Full-length piles shall be used where practicable. All piles shall be continuously driven unless otherwise allowed by NPC.
- h. In pile cluster, pile driving shall start at the center progressing outward in all directions. During driving, as the resistance increases, the rate of penetration is noted, generally by one foot markings on the pile, and when this rate has decreased considerably, the average penetration in inches per blow for the last 10 blows for diesel hammer shall be recorded and the safe bearing capacity of the pile is computed from the pile formulas. The safe bearing capacity shall be as called for in the drawings.
- i. All piles shall be driven until the minimum penetration obtained is satisfactory to NPC, regardless of the fact that the required bearing, as

determined by the pile formulas, may be obtained at a lesser depth.

#### **CW -7.6. Cutting of Piles**

- a. Tops of piles shall be embedded in the concrete capping as shown on the drawings.
- b. Concrete piles shall, when approved by NPC, be cut off at such level as shown on the drawings. If a pile is damaged below this level, the Contractor shall repair the pile in accordance with the procedure approved by NPC. The distance from the side of any pile to the nearest edge of the cap shall not be less than 300 mm.
- c. When the cut-off elevation for a prestressed concrete pile is below the elevation of the bottom of the pile cap, the pile may be built up from the butt of the pile to elevation of the bottom of the cap by means of a reinforced concrete extension to be approved by NPC.

#### **CW -7.7. Pile Formula**

For piles not driven to practical refusal and in lieu of loading tests, which are more preferable for piles other than timber piles, the bearing value for the piles shall be approximated by any applicable pile formula for the determination of allowable bearing capacity.

#### **CW -7.8. Pile Records**

The Contractor shall keep records of all piles driven. A copy of the record shall be given to NPC within 2 days after each pile is driven. The record form to be used shall be approved by NPC. The pile records shall give full information on the following:

- a. Pile Type and Dimension
- b. Date of casting and date of driving
- c. Driving equipment: type, weight and efficiency of hammer, etc.
- d. Depth driven and tip elevation
- e. Final set for the last 10 blows (for each group of pile and when the NPC so required, the penetration along the whole driven depth shall be recorded)
- f. Details of any interruption in driving
- g. Level of pile top immediately after driving and the level when all piles in the group are driven
- h. Details of re-driving, if any

On completion of the piling for each structure, the Contractor shall deliver to NPC a drawing recording the exact location and the final depth (tip elevation) of all piles.

#### **CW -7.9. Measurement and Payment**

Measurement for payment for pre-stressed concrete piles, as stated in the Bill of Quantities will be based on the number of piles driven and accepted by NPC times the lengths of piles in linear meters as determined from the result of the test pile.

Payment will be made at the contract unit price for the item Pre-stressed

Concrete Piles which payment shall constitute full compensation for furnishing all materials, labor, equipment and tools necessary to complete the item, including scaffoldings, supports and other incidentals attendant to pile driving.

Rejected piles shall not be included for payment.

**CW - 8.0 FENDER SYSTEM****CW -8.1. General**

This section covers the furnishing, delivery and installation of fender system in accordance with these specifications and in conformity with the drawings.

**CW -8.2. Materials**

Rubber fenders shall be rubber tire (used) with sizes as indicated in the drawings.

**CW -8.3. Anchorage Fastening**

Fastening details, anchors, bolts and nuts shall be stainless steel conforming to ASTM F-593 "Standard Specification for Stainless Steel Bolts, Hex Cap Screws, and Studs". The size and quantity of these accessories shall be determined in accordance with the capacity of the fender system and subject to NPC's approval.

All works shall be performed with the highest acceptable quality and completed in a thorough and workmanlike manner and shall follow the best modern practices in installation. The Contractor shall furnish all fastening, anchors and temporary bracings and other miscellaneous materials required during installation of rubber fenders.

**CW -8.4. Measurement and Payment**

Measurement for payment will be based on the number of fender system assembly installed and accepted by NPC.

Payment will be made at the contract unit price for the item, Rubber Fender in the Bill of Quantities, which payment shall include all costs of materials, labor, tools and incidentals including anchor bolts needed to complete the installation of the fender system.

SECTION VII

**BILL OF QUANTITIES**



SECTION VII - BILL OF QUANTITIES

**CIVIL WORKS**

| Item No.                                | Description of Work or Materials   | Work to Be Done   | Ref. | Unit   | Estimated Quantity | Unit Price in Pesos (Words and Figures) | Total Amount |
|---|--|---|------|--------|--------------------|---|--------------|
| <b>A. BREASTING DOLPHINS/STRUCTURES</b> |  |   |      |        |                    |   |              |
| a.                                      | Pre-stressed Concrete Piles<br>Length=30m/pc (12 pcs)<br>(see drawing for details) | supply, deliver, handle, pitch<br>drive, cut and splice | CW-7 | l.m.   | 360                | _____ (P _____)                         | P _____      |
| b.                                      | Concrete Pile Cap (20.7 MPa)   | furnish and construct                                   | CW-3 | cu. m. | 30                 | _____ (P _____)                         | P _____      |
| c.                                      | Reinforcing Steel  | furnish, cut<br>bend and install                        | CW-4 | kg     | 4,700              | _____ (P _____)                         | P _____      |
| d.                                      | Rubber Fender (used tire)<br>including bolts, nuts, anchorage, etc.                | furnish and install                                     | CW-8 | set    | 2                  | _____ (P _____)                         | P _____      |
| <b>TOTAL AMOUNT (CIVIL WORKS)</b>       |  |   |      |        |                    | _____ (P _____)                         | P _____      |

\_\_\_\_\_  
Name of Firm

\_\_\_\_\_  
Name and Signature of Authorized Representative

\_\_\_\_\_  
Designation



SECTION VIII

**BIDDING FORMS**



## SECTION VIII – BIDDING FORMS

### TABLE OF CONTENTS

|                |  |
|----------------|--|
| NPCSF-INFR-01  | - Checklist of Technical and Financial Envelope Requirements for Bidders   |
| NPCSF-INFR-02  | - List of all Ongoing Government & Private Construction Contracts Including Contracts Awarded but not yet Started                              |
| NPCSF-INFR-03  | - Statement of the bidder's Single Largest Completed Contract (SLCC) similar to the contract to be bid   |
| NPCSF-INFR-04  | - Computation of Net Financial Contracting Capacity (NFCC)   |
| NPCSF-INFR-05  | - Joint Venture Agreement  |
| NPCSF-INFR-06a | - Form of Bid Security : Bank Guarantee  |
| NPCSF-INFR-06b | - Form of Bid Security : Surety Bond   |
| NPCSF-INFR-06c | - Bid Securing Declaration Form  |
| NPCSF-INFR-07  | - Omnibus Sworn Statement (Revised)  |
| NPCSF-INFR-08  | - Contractor's Organizational Chart for the Project  |
| NPCSF-INFR-09  | - List of Key Personnel Proposed to be Assigned to the Project   |
| NPCSF-INFR-10a | - Key Personnel's Certificate of Employment (Professional Personnel) <b><u>(TO BE SUBMITTED DURING POST-QUALIFICATION)</u></b>                 |
| NPCSF-INFR-10b | - Key Personnel's Certificate of Employment (Construction Safety and Health Officer) <b><u>(TO BE SUBMITTED DURING POST-QUALIFICATION)</u></b> |
| NPCSF-INFR-11  | - Key Personnel's Bio-Data <b><u>(TO BE SUBMITTED DURING POST-QUALIFICATION)</u></b>   |
| NPCSF-INFR-12  | - List of Equipment, Owned or Leased and/or under Purchase Agreement, Pledged to the Proposed Project  |
| NPCSF-INFR-13  | - Bid Letter   |
| NPCSF-INFR-14  | - Detailed Cost Estimate Form  |
| NPCSF-INFR-15  | - Summary Sheets of Materials Prices, Labor Rates and Equipment Rental Rates   |



Standard Form No: NPCSF-INFR-01

**Checklist of Technical & Financial Envelope Requirements for Bidders**

**A. THE 1<sup>ST</sup> ENVELOPE (TECHNICAL COMPONENT) SHALL CONTAIN THE FOLLOWING:**

**1. ELIGIBILITY DOCUMENTS**

**a. (CLASS A)**

- PhilGEPs Certificate of Registration and Membership under Platinum Category (all pages) in accordance with Section 8.5.2 of the Revised IRR of RA. 9184;

**Note:** The failure by the prospective bidder to update its Certificate with the current and updated Class “A” eligibility documents shall result in the automatic suspension of the validity of its Certificate until such time that all of the expired Class “A” eligibility documents has been updated

- Special PCAB License in case of Joint Ventures; and registration for the type and cost of the contract to be bid
- Statement of all its ongoing government and private contracts if any, whether similar or not similar in nature and complexity to the contract to be bid (*NPCSF-INFR-02*)

- The Statement of the bidder’s Single Largest Completed Contract (SLCC) similar to the contract to be bid, and whose value, adjusted to current prices using the Philippine Statistics Authority (PSA) consumer price index, must be at least 50% of the ABC (*NPCSF-INFR-03*) complete with the following supporting documents:

- Contract/Purchase Order
- Owner’s Certificate of Final Acceptance issued by the project owner other than the contractor or a final rating of at least Satisfactory in the Constructors Performance Evaluation System (CPES). In case of contracts with the private sector, an equivalent document (Ex. Official Receipt or Sales Invoice) shall be submitted

*(The Single Largest Completed Contract (SLCC) as declared by the bidder shall be verified and validated to ascertain such completed contract. Hence, bidders must ensure access to sites of such projects/equipment to NPC representatives for verification and validation purposes during post-qualification process.*

*It shall be a ground for disqualification, if verification and validation cannot be conducted due to inaccessibility of the site for whatever reason or fault of the bidder.)*

- Duly signed computation of its Net Financial Contracting Capacity (NFCC) at least equal to the ABC (*NPCSF-INFR-04*);

**b. (CLASS B)**

- Valid Joint Venture Agreement, if applicable (*NPCSF-INFR-05*)

Standard Form No: NPCSF-INFR-01  
Page 2 of 3

## 2. Technical Documents

- Bid Security, any one of the following:
  - Bid Securing Declaration (*NPCSF-INFR-06c*)  
**OR**
  - Cash or Cashier's/Manager's check issued by a Universal or Commercial Bank – 2% of ABC;  
**OR**
  - Bank draft/guarantee or irrevocable letter of credit issued by a Universal or Commercial Bank: (*NPCSF-INFR-06a*) - 2% of ABC;  
**OR**
  - Surety Bond callable upon demand issued by a reputable surety or insurance company (*NPCSF-INFR-06b*) - 5% of ABC, with
    - Certification from the Insurance Commission as authorized company to issue surety
- Duly signed, completely filled-out and notarized Omnibus Sworn statement (Revised) (*NPCSF-INFR-07*), complete with the following attachments:
  - For Sole Proprietorship:
    - Special Power of Attorney
  - For Partnership/Corporation/Cooperative/Joint Venture:
    - Document showing proof of authorization (e.g., duly notarized Secretary's Certificate, Board/Partnership Resolution, or Special Power of Attorney, whichever is applicable)
- Organization Chart for the project (*NPCSF-INFR-08*)
- Duly Signed and completely filled-out List of Contractor's Key Personnel (based on the minimum key personnel) (*NPCSF-INFR-09*)
- Duly Signed List of Contractor's Equipment (owned, leased or under purchase agreement (*NPCSF-INFR-12*), with
  - Proof of ownership and/or certificate of availability issued by Equipment Lessors
- Complete eligibility documents of proposed sub-contractor, if applicable

### **B. THE 2<sup>ND</sup> ENVELOPE (FINANCIAL COMPONENT) SHALL CONTAIN THE FOLLOWING:**

- Duly signed Bid Letter indicating the total bid amount in accordance with the prescribed form (*NPCSF-INFR-13*)
- Duly signed and completely filled-out Bill of Quantities (*Section VII*) indicating the unit and total prices per item and the total amount in the prescribed Bill of Quantities form.
- Duly Signed Detailed Estimates for each items of work showing the computations in arriving at each item's unit prices used in coming up with the bid (*NPCSF-INFR-14*)
- Summary sheets indicating the direct unit prices of construction materials, labor rates and equipment rental rates used in coming up with the bid (*NPCSF-INFR-15*)

*This Checklist of Requirements shall be provided to prospective suppliers/contractors including all forms. Suppliers/contractors are encouraged to consult this checklist before submitting their proposals on the deadline for the submission and receipt of offers.*

Standard Form No: NPCSF-INFR-01  
Page 3 of 3

**CONDITIONS:**

1. *Each Bidder shall submit Two (2) copies of the first and second components of its Bid, marked Original and photocopy. Only the original copy will be read and considered for the bid. Any misplaced document outside of the Original copy will not be considered. The photocopy is ONLY FOR REFERENCE. NPC may request additional hard copies and/or electronic copies of the Bid. However, failure of the Bidders to comply with the said request shall not be a ground for disqualification.*
2. *A Bidder not submitting bid for reason that his cost estimate is higher than the ABC, is required to submit his letter of non-participation/regret supported by corresponding detailed estimates. Failure to submit the two (2) documents shall be understood as acts that tend to defeat the purpose of public bidding without valid reason as stated under Section 69.1.(i) of the revised IRR of R.A. 9184.*



Standard Form Number: NPCSF-INFR-03

**The Statement of the bidder's Single Largest Completed Contract (SLCC) similar to the contract to be bid**

Business Name : \_\_\_\_\_  
 Business Address : \_\_\_\_\_

| Name of Contract | a. Owner's Name<br>b. Address<br>c. Telephone Nos. | Nature of Work | Contractor's Role |   | a. Amount at Award<br>b. Amount at Completion<br>c. Duration | a. Date Awarded<br>b. Contract Effectivity<br>c. Date Completed |
|------------------|--|----------------|-------------------|---|--|---|
|                  |  |                | Description       | % |  |   |
|                  |  |                |                   |   |  |   |

- Notes: 1. The bidder must state only one (1) Single Largest Completed Contract (SLCC) similar to the contract to be bid.  
 2. Supporting documents such as Contract/Purchase Order and any of the following: Owner's Certificate of Final Acceptance issued by the project owner other than the contractor; or A final rating of at least Satisfactory in the Constructors Performance Evaluation System (CPES); or Official Receipt (O.R); or Sales Invoice for the contract stated above shall be submitted during Bid Opening.

Submitted by \_\_\_\_\_  
 (Printed Name & Signature)

Designation : \_\_\_\_\_  
 Date : \_\_\_\_\_

Standard Form Number: NPCSF-INFR-04

**NET FINANCIAL CONTRACTING CAPACITY (NFCC)**

- A. Summary of the Bidder's/Contractor's assets and liabilities on the basis of the income tax return and audited financial statement for the immediately preceding calendar year are:

|    |                           | Year 20__ |
|----|---------------------------|-----------|
| 1. | Total Assets              |           |
| 2. | Current Assets            |           |
| 3. | Total Liabilities         |           |
| 4. | Current Liabilities       |           |
| 5. | Net Worth (1-3)           |           |
| 6. | Net Working Capital (2-4) |           |

- B. The Net Financial Contracting Capacity (NFCC) based on the above data is computed as follows:

NFCC = [(Current assets minus current liabilities) x 15] minus the value of all outstanding or uncompleted portions of the projects under ongoing contracts, including awarded contracts yet to be started coinciding with the contract for this Project.

NFCC = P \_\_\_\_\_

Herewith attached is certified true copy of the audited financial statement, stamped "RECEIVED" by the BIR or BIR authorized collecting agent for the immediately preceding calendar year.

Submitted by:

\_\_\_\_\_  
Name of Bidder/Contractor

\_\_\_\_\_  
Signature of Authorized Representative

Date : \_\_\_\_\_

Standard Form Number: NPCSF-INFR-05

**JOINT VENTURE AGREEMENT**

**KNOW ALL MEN BY THESE PRESENTS:**

That this JOINT VENTURE AGREEMENT is entered into by and between: \_\_\_\_\_, of legal age, (*civil status*) \_\_\_\_\_, authorized representative of \_\_\_\_\_ and a resident of \_\_\_\_\_.

- and -

\_\_\_\_\_, of legal age, (*civil status*) \_\_\_\_\_, authorized representative of \_\_\_\_\_ a resident of \_\_\_\_\_.

That both parties agree to join together their capital, manpower, equipment, and other resources and efforts to enable the Joint Venture to participate in the Bidding and Undertaking of the hereunder stated Contract of the **National Power Corporation**.

**NAME OF PROJECT**

**CONTRACT AMOUNT**

That the capital contribution of each member firm:

| NAME OF FIRM | CAPITAL CONTRIBUTION |
|--------------|----------------------|
| 1.           | P                    |
| 2.           | P                    |

That both parties agree to be jointly and severally liable for their participation in the Bidding and Undertaking of the said contract.

That both parties agree that \_\_\_\_\_ and/or \_\_\_\_\_ shall be the Official Representative/s of the Joint Venture, and are granted full power and authority to do, execute and perform any and all acts necessary and/or to represent the Joint Venture in the Bidding and Undertaking of the said contract, as fully and effectively and the Joint Venture may do and if personally present with full power of substitution and revocation.

That this Joint Venture Agreement shall remain in effect only for the above stated Contract until terminated by both parties.

\_\_\_\_\_  
*Name & Signature of Authorized Representative*

\_\_\_\_\_  
*Official Designation*

\_\_\_\_\_  
*Name of Firm*

\_\_\_\_\_  
*Name & Signature of Authorized Representative*

\_\_\_\_\_  
*Official Designation*

\_\_\_\_\_  
*Name of Firm*

*Witnesses*

1. \_\_\_\_\_ 2. \_\_\_\_\_

**[Jurat]**

*[Format shall be based on the latest Rules on Notarial Practice]*

Standard Form Number: NPCSF-INFR-06a

**FORM OF BID SECURITY (BANK GUARANTEE)**

WHEREAS, (Name of Bidder) (hereinafter called "the Bidder") has submitted his bid dated (Date) for the [name of project] (hereinafter called "the Bid").

KNOW ALL MEN by these presents that We (Name of Bank) of (Name of Country) having our registered office at \_\_\_\_\_ (hereinafter called "the Bank" are bound unto National Power Corporation (hereinafter called "the Entity") in the sum of [amount in words & figures as prescribed in the bidding documents] for which payment well and truly to be made to the said Entity the Bank binds himself, his successors and assigns by these presents.

SEALED with the Common Seal of the said Bank this \_\_\_\_ day of \_\_\_\_\_ 20\_\_.

THE CONDITIONS of this obligation are that:

- 1) if the Bidder withdraws his Bid during the period of bid validity specified in the Bidding Documents; or
- 2) if the Bidder does not accept the correction of arithmetical errors of his bid price in accordance with the Instructions to Bidder; or
- 3) if the Bidder, having determined as the LCB, fails or refuses to submit the required tax clearance, latest income and business tax returns and PhilGEPs registration certificate within the prescribed period; or
- 4) if the Bidder having been notified of the acceptance of his bid and award of contract to him by the Entity during the period of bid validity:
  - a) fails or refuses to execute the Contract; or
  - b) fails or refuses to submit the required valid JVA, if applicable; or
  - c) fails or refuses to furnish the Performance Security in accordance with the Instructions to Bidders;

we undertake to pay to the Entity up to the above amount upon receipt of his first written demand, without the Entity having to substantiate its demand, provided that in his demand the Entity will note that the amount claimed by it is due to the occurrence of any one or combination of the four (4) conditions stated above.

The Guarantee will remain in force up to 120 days after the opening of bids or as it may be extended by the Entity, notice of which extension(s) to the Bank is hereby waived. Any demand in respect of this Guarantee should reach the Bank not later than the above date.

DATE \_\_\_\_\_ SIGNATURE OF THE BANK \_\_\_\_\_

WITNESS \_\_\_\_\_ SEAL \_\_\_\_\_

\_\_\_\_\_  
(Signature, Name and Address)



Standard Form Number: NPCSF-INFR-06b

**FORM OF BID SECURITY (SURETY BOND)**

BOND NO.: \_\_\_\_\_ DATE BOND EXECUTED: \_\_\_\_\_

By this bond, We (*Name of Bidder*) \_\_\_\_\_ (hereinafter called "the Principal") and (*Name of Surety*) \_\_\_\_\_ of (*Name of Country of Surety*) \_\_\_\_\_, authorized to transact business in the Philippines (hereinafter called "the Surety") are held and firmly bound unto National Power Corporation (hereinafter called "the Employer") as Obligee, in the sum of (*amount in words & figures as prescribed in the bidding documents*), callable on demand, for the payment of which sum, well and truly to be made, we, the said Principal and Surety bind ourselves, our successors and assigns, jointly and severally, firmly by these presents.

SEALED with our seals and dated this \_\_\_\_\_ day of \_\_\_\_\_ 20 \_\_\_\_\_

WHEREAS, the Principal has submitted a written Bid to the Employer dated the \_\_\_\_\_ day of \_\_\_\_\_ 20 \_\_\_\_\_, for the \_\_\_\_\_ (hereinafter called "the Bid").

NOW, THEREFORE, the conditions of this obligation are:

- 1) if the Bidder withdraws his Bid during the period of bid validity specified in the Bidding Documents; or
- 2) if the Bidder does not accept the correction of arithmetical errors of his bid price in accordance with the Instructions to Bidder; or
- 3) if the Bidder, having determined as the LCB, fails or refuses to submit the required tax clearance, latest income and business tax returns and PhilGEP's registration certificate within the prescribed period; or
- 4) if the Bidder having been notified of the acceptance of his bid and award of contract to him by the Entity during the period of bid validity:
  - d) fails or refuses to execute the Contract; or
  - e) fails or refuses to submit the required valid JVA, if applicable; or
  - f) fails or refuses to furnish the Performance Security in accordance with the Instructions to Bidders;

then this obligation shall remain in full force and effect, otherwise it shall be null and void.

PROVIDED HOWEVER, that the Surety shall not be:

- a) liable for a greater sum than the specified penalty of this bond, nor
- b) liable for a greater sum than the difference between the amount of the said Principal's Bid and the amount of the Bid that is accepted by the Employer.

Standard Form Number: NPCSF-INFR-06b  
Page 2 of 2

This Surety executing this instrument hereby agrees that its obligation shall be valid for 120 calendar days after the deadline for submission of Bids as such deadline is stated in the Instructions to Bidders or as it may be extended by the Employer, notice of which extension(s) to the Surety is hereby waived.

PRINCIPAL \_\_\_\_\_ SURETY \_\_\_\_\_

SIGNATURE(S) \_\_\_\_\_ SIGNATURES(S) \_\_\_\_\_

NAME(S) AND TITLE(S) \_\_\_\_\_ NAME(S) \_\_\_\_\_

SEAL \_\_\_\_\_ SEAL \_\_\_\_\_

Standard Form No: NPCSF-INFR-06c

REPUBLIC OF THE PHILIPPINES )
CITY OF \_\_\_\_\_ ) S.S.

BID-SECURING DECLARATION
CONSTRUCTION OF ADDITIONAL BREASTING STRUCTURES FOR POWER BARGE
120 AT MOGPOG, MARINDUQUE
LuzP23Z1586Sc

To: National Power Corporation
BIR Road cor. Quezon Ave.
Diliman, Quezon City

I/We1, the undersigned, declare that:

- 1. I/We understand that, according to your conditions, bids must be supported by a Bid Security, which may be in the form of a Bid-Securing Declaration.
2. I/We accept that: (a) I/we will be automatically disqualified from bidding for any contract with any procuring entity for a period of two (2) years upon receipt of your Blacklisting Order; and, (b) I/we will pay the applicable fine provided under Section 6 of the Guidelines on the Use of Bid Securing Declaration, within fifteen (15) days from receipt of the written demand by the Procuring Entity for the commission of acts resulting to the enforcement of the Bid Securing Declaration under Sections 23.1 (b), 34.2, 40.1 and 69.1, except 69.1 (f) of the IRR of R.A. 9184; without prejudice to other legal action the government may undertake.
3. I/We understand that this Bid-Securing Declaration shall cease to be valid on the following circumstances:
(a) Upon expiration of the bid validity period, or any extension thereof pursuant to your request;
(b) I am/we are declared ineligible or post-disqualified upon receipt of your notice to such effect, and (i) I/we failed to timely file a request for reconsideration or (ii) I/we filed a waiver to avail of said right;
(c) I am/we are declared as the bidder with the Lowest Calculated and Responsive Bid, and I/we have furnished the performance security and signed the Contract.

IN WITNESS WHEREOF, I/we have hereunto set my hand this \_\_\_ day of \_\_\_
20\_\_\_ at \_\_\_\_\_, Philippines.

[Name and Signature of Bidder's Representative/
Authorized Signatory]/ [Signatory's legal capacity]
Affiant

[Jurat]

[Format shall be based on the latest Rules on Notarial Practice]

1 Select one and delete the other. Adopt same instruction for similar terms throughout the document.

Standard Form No: NPCSF-INFR-07b

### Omnibus Sworn Statement (Revised)

REPUBLIC OF THE PHILIPPINES )  
CITY/MUNICIPALITY OF \_\_\_\_\_ ) S.S.

#### AFFIDAVIT

I, [Name of Affiant], of legal age, [Civil Status], [Nationality], and residing at [Address of Affiant], after having been duly sworn in accordance with law, do hereby depose and state that:

1. *[Select one, delete the other:]*

*[If a sole proprietorship:]* I am the sole proprietor or authorized representative of [Name of Bidder] with office address at [address of Bidder];

*[If a partnership, corporation, cooperative, or joint venture:]* I am the duly authorized and designated representative of [Name of Bidder] with office address at [address of Bidder];

2. *[Select one, delete the other:]*

*[If a sole proprietorship:]* As the owner and sole proprietor, or authorized representative of [Name of Bidder], I have full power and authority to do, execute and perform any and all acts necessary to participate, submit the bid, and to sign and execute the ensuing contract for [Name of the Project] of the [Name of the Procuring Entity], as shown in the attached duly notarized Special Power of Attorney;

*[If a partnership, corporation, cooperative, or joint venture:]* I am granted full power and authority to do, execute and perform any and all acts necessary to participate, submit the bid, and to sign and execute the ensuing contract for [Name of the Project] of the [Name of the Procuring Entity], as shown in the attached [state title of attached document showing proof of authorization (e.g., duly notarized Secretary's Certificate, Board/Partnership Resolution, or Special Power of Attorney, whichever is applicable)];

3. [Name of Bidder] is not "blacklisted" or barred from bidding by the Government of the Philippines or any of its agencies, offices, corporations, or Local Government Units, foreign government/foreign or international financing institution whose blacklisting rules have been recognized by the Government Procurement Policy Board, by itself or by relation, membership, association, affiliation, or controlling interest with another blacklisted person or entity as defined and provided for in the Uniform Guidelines on Blacklisting;

4. Each of the documents submitted in satisfaction of the bidding requirements is an authentic copy of the original, complete, and all statements and information provided therein are true and correct;

5. [Name of Bidder] is authorizing the Head of the Procuring Entity or its duly authorized representative(s) to verify all the documents submitted;

6. *[Select one, delete the rest:]*

*[If a sole proprietorship:]* The owner or sole proprietor is not related to the Head of the Procuring Entity, members of the Bids and Awards Committee (BAC), the Technical Working Group, and the BAC Secretariat, the head of the Project Management Office or the end-user unit, and the project consultants by consanguinity or affinity up to the third civil degree;

*[If a partnership or cooperative:]* None of the officers and members of *[Name of Bidder]* is related to the Head of the Procuring Entity, members of the Bids and Awards Committee (BAC), the Technical Working Group, and the BAC Secretariat, the head of the Project Management Office or the end-user unit, and the project consultants by consanguinity or affinity up to the third civil degree;

*[If a corporation or joint venture:]* None of the officers, directors, and controlling stockholders of *[Name of Bidder]* is related to the Head of the Procuring Entity, members of the Bids and Awards Committee (BAC), the Technical Working Group, and the BAC Secretariat, the head of the Project Management Office or the end-user unit, and the project consultants by consanguinity or affinity up to the third civil degree;

7. *[Name of Bidder]* complies with existing labor laws and standards; and
8. *[Name of Bidder]* is aware of and has undertaken the responsibilities as a Bidder in compliance with the Philippine Bidding Documents, which includes:
  - a. Carefully examining all of the Bidding Documents;
  - b. Acknowledging all conditions, local or otherwise, affecting the implementation of the Contract;
  - c. Making an estimate of the facilities available and needed for the contract to be bid, if any; and
  - d. Inquiring or securing Supplemental/Bid Bulletin(s) issued for the *[Name of the Project]*.
9. *[Name of Bidder]* did not give or pay directly or indirectly, any commission, amount, fee, or any form of consideration, pecuniary or otherwise, to any person or official, personnel or representative of the government in relation to any procurement project or activity.
10. In case advance payment was made or given, failure to perform or deliver any of the obligations and undertakings in the contract shall be sufficient grounds to constitute criminal liability for Swindling (Estafa) or the commission of fraud with unfaithfulness or abuse of confidence through misappropriating or converting any payment received by a person or entity under an obligation involving the duty to deliver certain goods or services, to the prejudice of the public and the government of the Philippines pursuant to Article 315 of Act No. 3815 s. 1930, as amended, or the Revised Penal Code.

IN WITNESS WHEREOF, I have hereunto set my hand this \_\_ day of \_\_, 20\_\_ at \_\_\_\_\_, Philippines.

*[Insert NAME OF BIDDER OR ITS AUTHORIZED REPRESENTATIVE]*  
*[Insert signatory's legal capacity]*  
Affiant

**[Jurat]**  
*[Format shall be based on the latest Rules on Notarial Practice]*

Standard Form Number: NPCSF-INFR-08

## CONTRACTOR'S ORGANIZATIONAL CHART FOR THE CONTRACT

Submit Copy of the Organizational Chart that the Contractor intends to use to execute the Contract if awarded to him. Indicate in the chart the names of the Project Manager, Project Engineer, Foreman and other Key Engineering Personnel.

Attach the required Proposed Organizational Chart for the Contract as stated above

### NOTES:

1. *This organization chart should represent the "Contractor's Organization" required for the Project, and not the organizational chart of the entire firm.*
2. *Each such nominated engineer/key personnel shall comply with and submit duly accomplished forms NPCSF-INFR-10a, NPCSF-INFR-10b and NPCSF-INFR-11, which shall be submitted during post-qualification.*
3. *All these are required to be in the Technical Envelope of the Bidder.*

Standard Form Number: NPCSF-INFR-09

**LIST OF KEY PERSONNEL PROPOSED TO BE ASSIGNED TO THE CONTRACT**  
*(Based on the Minimum Key Personnel Required in the Bidding Documents)*

Business Name: \_\_\_\_\_  
 Business: \_\_\_\_\_

| Particulars  | Project Manager<br>(if applicable) | Project Engineer | Materials Engineer<br>(if applicable) | Safety Officer |  |
|--|------------------------------------|------------------|---------------------------------------|----------------|--|
| 1 Name   |                                    |                  |                                       |                |  |
| 2 Address  |                                    |                  |                                       |                |  |
| 3 Date of Birth                                      |                                    |                  |                                       |                |  |
| 4 Education  |                                    |                  |                                       |                |  |
| 5 License/Qualification Details:                     |                                    |                  |                                       |                |  |
| a. Profession/Specialization                         |                                    |                  |                                       |                |  |
| b. Registration Number                               |                                    |                  |                                       |                |  |
| c. Registration Date                                 |                                    |                  |                                       |                |  |
| d. Valid Until                                       |                                    |                  |                                       |                |  |
| 6 Experience Data:                                   |                                    |                  |                                       |                |  |
| a. Years employed by the Bidder                      |                                    |                  |                                       |                |  |
| b. General Experience (yrs.)                         |                                    |                  |                                       |                |  |
| c. Professional Experience on similar project (yrs.) |                                    |                  |                                       |                |  |

Submitted by: \_\_\_\_\_  
*(Printed Name & Signature)*  
 Designation: \_\_\_\_\_  
 Date: \_\_\_\_\_

*One of the requirements from the bidder to be included in its Technical Envelope is a list of contractor's key personnel (based on the minimum key personnel required in the bidding documents) to be assigned to the contract to be bid, with their complete qualification and experience data.*

Standard Form Number: NPCSF-INFR-10a

**NOTE: THIS FORM SHALL BE SUBMITTED DURING POST-QUALIFICATION**

**KEY PERSONNEL'S CERTIFICATE OF EMPLOYMENT  
(PROFESSIONAL PERSONNEL)**

\_\_\_\_\_  
*Issuance Date*

**THE PRESIDENT**

National Power Corporation  
BIR Road cor. Quezon Ave.  
Diliman, Quezon City

Dear Sir:

I am (Name of Nominee) a Licensed \_\_\_\_\_ Engineer with Professional License No. \_\_\_\_\_ issued on (date of issuance) at (place of issuance).

I hereby certify that (Name of Bidder) has engaged my services as (Designation) for the (Name of Project), if awarded to it.

As (Designation), I supervised the following completed projects similar to the contract under bidding:

| NAME OF PROJECT | OWNER | COST  | DATE COMPLETED |
|-----------------|-------|-------|----------------|
| _____           | _____ | _____ | _____          |

At present, I am supervising the following projects:

| NAME OF PROJECT | OWNER | COST  | DATE COMPLETED |
|-----------------|-------|-------|----------------|
| _____           | _____ | _____ | _____          |

In case of my separation for any reason whatsoever from the above-mentioned Contractor, I shall notify the National Power Corporation at least twenty one (21) days before the effective date of my separation.

As (Designation), I know I will have to stay in the job site all the time to supervise and manage the Contract works to the best of my ability, and aware that I am authorized to handle only one (1) contract at a time.

I do not allow the use of my name for the purpose of enabling the above-mentioned Contractor to qualify for the Contract without any firm commitment on my part to assume the post of (Designation) therefor, if the contract is awarded to him since I understand that to do so will be a sufficient ground for my disqualification as (Designation) in any future National Power Corporation bidding or employment with any Contractor doing business with the National Power Corporation.

\_\_\_\_\_  
*(Name and Signature)*  
AFFIANT

**[Jurat]**

*[Format shall be based on the latest Rules on Notarial Practice]*

One of the requirements from the bidder is a list of contractor's key personnel (viz. Project Manager, Project Engineer, Construction Safety Officer, Foremen, etc), to be assigned to the contract to be bid, with their complete qualification and experience data (including the key personnel's signed written commitment to work for the project once awarded the contract).



Standard Form Number: NPCSF-INFR-10b

NOTE: THIS FORM SHALL BE SUBMITTED DURING POST-QUALIFICATION

KEY PERSONNEL'S CERTIFICATE OF EMPLOYMENT (CONSTRUCTION SAFETY AND HEALTH OFFICER)

Issuance Date

THE PRESIDENT

National Power Corporation
BIR Road cor. Quezon Ave.
Diliman, Quezon City

Dear Sir:

I am (Name of Nominee) an Construction Safety & Health Officer with Certificate No. issued on (date of issuance) at (place of issuance).

I hereby certify that (Name of Bidder) has engaged my services as Construction Safety & Health Officer for the (Name of Project), if awarded to it.

I am the Construction Safety & Health Officer of the following completed projects similar to the contract under bidding:

Table with 4 columns: NAME OF PROJECT, OWNER, COST, DATE COMPLETED

At present, I am the Construction Safety & Health Officer of the following projects:

Table with 4 columns: NAME OF PROJECT, OWNER, COST, DATE COMPLETED

In case of my separation for any reason whatsoever from the above-mentioned Contractor, I shall notify the National Power Corporation at least twenty one (21) days before the effective date of my separation.

As Construction Safety & Health Officer, I know I will have to stay in the job site all the time and aware that I am authorized to handle only one (1) contract at a time.

I do not allow the use of my name for the purpose of enabling the above-mentioned Contractor to qualify for the Contract without any firm commitment on my part to assume the post of Construction Safety & Health Officer, if the contract is awarded to him since I understand that to do so will be a sufficient ground for my disqualification as Construction Safety & Health Officer in any future National Power Corporation bidding or employment with any Contractor doing business with the National Power Corporation.

(Name and Signature)
AFFIANT

[Jurat]

[Format shall be based on the latest Rules on Notarial Practice]

One of the requirements from the bidder is a list of contractor's key personnel (viz. Project Manager, Project Engineer, Construction Safety Officer, Foremen, etc), to be assigned to the contract to be bid, with their complete qualification and experience data (including the key personnel's signed written commitment to work for the project once awarded the contract).

Standard Form Number: NPCSF-INFR-11

**NOTE: THIS FORM SHALL BE SUBMITTED DURING  
POST-QUALIFICATION**

**KEY PERSONNEL  
(FORMAT OF BIO-DATA)**

Give the detailed information of the following personnel who are scheduled to be assigned as full-time field staff for the project. Fill up a form for each person.

- 1. Name : \_\_\_\_\_
- 2. Date of Birth : \_\_\_\_\_
- 3. Nationality : \_\_\_\_\_
- 4. Education and Degrees : \_\_\_\_\_
- 5. Specialty : \_\_\_\_\_
- 6. Registration : \_\_\_\_\_
- 7. Length of Service with the Firm : \_\_\_\_\_ Year from \_\_\_\_\_ (months) \_\_\_\_\_ (year)  
To \_\_\_\_\_ (months) \_\_\_\_\_ (year)
- 8. Years of Experience : \_\_\_\_\_
- 9. If Item 7 is less than ten (10) years, give name and length of service with previous employers for a ten (10)-year period (attached additional sheet/s), if necessary:

| <u>Name and Address of Employer</u> | <u>Length of Service</u>          |
|-------------------------------------|-----------------------------------|
| _____                               | _____ year(s) from _____ to _____ |
| _____                               | _____ year(s) from _____ to _____ |
| _____                               | _____ year(s) from _____ to _____ |

- 10. Experience:  
  
This should cover the past ten (10) years of experience. (Attached as many pages as necessary to show involvement of personnel in projects using the format below).

*One of the requirements from the bidder is a list of contractor's key personnel (viz. Project Manager, Project Engineer, Construction Safety Officer, Foremen, etc), to be assigned to the contract to be bid, with their complete qualification and experience data (including the key personnel's signed written commitment to work for the project once awarded the contract).*

Standard Form Number: NPCSF-INFR-11  
Page 2 of 2

- 1. Name : \_\_\_\_\_
- 2. Name and Address of Owner : \_\_\_\_\_
- 3. Name and Address of the  
Owner's Engineer  
(Consultant) : \_\_\_\_\_
- 4. Indicate the Features of Project  
(particulars of the project  
components and any other particular  
interest connected with the project): \_\_\_\_\_
- 5. Contract Amount Expressed in  
Philippine Currency : \_\_\_\_\_
- 6. Position : \_\_\_\_\_
- 7. Structures for which the employee  
was responsible : \_\_\_\_\_
- 8. Assignment Period : from \_\_\_\_\_ (months) \_\_\_\_\_ (years)  
: to \_\_\_\_\_ (months) \_\_\_\_\_ (years)

\_\_\_\_\_  
Name and Signature of Employee

It is hereby certified that the above personnel can be assigned to this project, if the contract is awarded to our company.

\_\_\_\_\_  
(Place and Date)

\_\_\_\_\_  
(The Authorized Representative)

*One of the requirements from the bidder is a list of contractor's key personnel (viz. Project Manager, Project Engineer, Construction Safety Officer, Foreman, etc), to be assigned to the contract to be bid, with their complete qualification and experience data (including the key personnel's signed written commitment to work for the project once awarded the contract).*

Standard Form Number: NPCSF-INFR-12

**LIST OF EQUIPMENT, OWNED OR LEASED AND/OR UNDER PURCHASE AGREEMENTS**  
*(Based on the Minimum Equipment Required in the Bidding Documents)*

Business Name: \_\_\_\_\_  
Business: \_\_\_\_\_

| Description                         | Model/Year | Capacity / Performance / Size | Plate No. | Motor No. / Body No. | Location | Condition | Proof of Ownership / Lessor or Vendor |
|-------------------------------------|------------|-------------------------------|-----------|----------------------|----------|-----------|---------------------------------------|
| <b>A. Owned</b>                     |            |                               |           |                      |          |           |                                       |
| i.                                  |            |                               |           |                      |          |           |                                       |
| ii.                                 |            |                               |           |                      |          |           |                                       |
| iii.                                |            |                               |           |                      |          |           |                                       |
| iv.                                 |            |                               |           |                      |          |           |                                       |
| v.                                  |            |                               |           |                      |          |           |                                       |
| <b>B. Leased</b>                    |            |                               |           |                      |          |           |                                       |
| i.                                  |            |                               |           |                      |          |           |                                       |
| ii.                                 |            |                               |           |                      |          |           |                                       |
| iii.                                |            |                               |           |                      |          |           |                                       |
| iv.                                 |            |                               |           |                      |          |           |                                       |
| v.                                  |            |                               |           |                      |          |           |                                       |
| <b>C. Under Purchase Agreements</b> |            |                               |           |                      |          |           |                                       |
| i.                                  |            |                               |           |                      |          |           |                                       |
| ii.                                 |            |                               |           |                      |          |           |                                       |
| iii.                                |            |                               |           |                      |          |           |                                       |
| iv.                                 |            |                               |           |                      |          |           |                                       |
| v.                                  |            |                               |           |                      |          |           |                                       |

Submitted by: \_\_\_\_\_  
*(Printed Name & Signature)*

Designation: \_\_\_\_\_

Date: \_\_\_\_\_

*One of the requirements from the bidder to be included in its Technical Envelope is the list of its equipment units pledged for the contract to be bid, based on minimum equipment required in the bidding docs. which are owned (supported by proof/s of ownership), leased, and/or under purchase agreements (with corresponding engine numbers, chassis numbers and/or serial numbers), supported by certification of availability of equipment from the equipment lessor/vendor for the duration of the project*

Standard Form No. : NPCSF-INFR-13

**BID LETTER**

Date: \_\_\_\_\_

To: **THE PRESIDENT**  
National Power Corporation  
BIR Road cor. Quezon Ave.  
Diliman, Quezon City

We, the undersigned, declare that:

(a) We have examined and have no reservation to the Bidding Documents, including Addenda, for the Contract **CONSTRUCTION OF ADDITIONAL BREASTING STRUCTURES FOR POWER BARGE 120 AT MOGPOG, MARINDUQUE (LuzP23Z1586Sc)**.

(b) We offer to execute the Works for this Contract in accordance with the Bid Documents, Technical Specifications, General and Special Conditions of Contract accompanying this Bid;

The total price of our Bid, excluding any discounts offered below is: [insert information] \_\_\_\_\_;

The discounts offered and the methodology for their application are: [insert information] \_\_\_\_\_;

(c) Our Bid shall be valid for a period of [insert number] \_\_\_\_\_ days from the date fixed for the Bid submission deadline in accordance with the Bidding Documents, and it shall remain binding upon us and may be accepted at any time before the expiration of that period;

(d) If our Bid is accepted, we commit to obtain a Performance Security in the amount of [insert percentage amount] \_\_\_\_\_ percent of the Contract Price for the due performance of the Contract;

(e) Our firm, including any subcontractors or suppliers for any part of the Contract, have nationalities from the following eligible countries: [insert information] \_\_\_\_\_;

(f) We are not participating, as Bidders, in more than one Bid in this bidding process, other than alternative offers in accordance with the Bidding Documents;

(g) Our firm, its affiliates or subsidiaries, including any subcontractors or suppliers for any part of the Contract, has not been declared ineligible by the Funding Source;

(h) We understand that this Bid, together with your written acceptance thereof included in your notification of award, shall constitute a binding contract between us, until a formal Contract is prepared and executed; and

(i) We understand that you are not bound to accept the Lowest Calculated Bid or any other Bid that you may receive.

(j) We likewise certify/confirm that the undersigned, is the duly authorized representative of the bidder, and granted full power and authority to do, execute and perform any and all acts necessary to participate, submit the bid, and to sign and

execute the ensuing contract for the **CONSTRUCTION OF ADDITIONAL BREASTING STRUCTURES FOR POWER BARGE 120 AT MOGPOG, MARINDUQUE (LuzP23Z1586Sc)** of the National Power Corporation.

- (k) We acknowledge that failure to sign each and every page of this Bid Letter, including the Bill of Quantities, shall be a ground for the rejection of our bid.

Name: \_\_\_\_\_

In the capacity of: \_\_\_\_\_

Signed: \_\_\_\_\_

Duly authorized to sign the Bid for and on behalf of: \_\_\_\_\_

Date: \_\_\_\_\_



Standard Form No. : NPCSF-INFR-15

**SUMMARY SHEETS OF MATERIALS PRICES, LABOR RATES  
AND EQUIPMENT RENTAL RATES**

Name of Bidder : \_\_\_\_\_  
\_\_\_\_\_

**I. Unit Prices of Materials**

| Materials Description | Unit | Unit Price |
|-----------------------|------|------------|
| 1.                    |      |            |
| 2.                    |      |            |
| 3.                    |      |            |
| 4.                    |      |            |
| 5.                    |      |            |
| 6.                    |      |            |
| 7.                    |      |            |

**II. Manpower Hourly Rates**

| Designation | Rate/Hr. |
|-------------|----------|
| 1.          |          |
| 2.          |          |
| 3.          |          |
| 4.          |          |
| 5.          |          |
| 6.          |          |
| 7.          |          |

**III. Equipment Hourly Rental Rates**

| Equipment Description | Rental Rate/Hr. |
|-----------------------|-----------------|
| 1.                    |                 |
| 2.                    |                 |
| 3.                    |                 |
| 4.                    |                 |
| 5.                    |                 |
| 6.                    |                 |
| 7.                    |                 |

\_\_\_\_\_  
Name, Signature of Authorized Representative

\_\_\_\_\_  
Designation



SECTION IX  
**BID DRAWINGS**



**SECTION IX – BID/REFERENCE DRAWINGS****CW – CIVIL WORKS**

| <b><u>DRAWING NO.</u></b> | <b><u>TITLE</u></b>                                  |
|---------------------------|--|
| ABSM-BDC-14.001           | GENERAL LAYOUT                                       |
| ABSM-BDC-14.002           | SITE DEVELOPMENT PLAN                                |
| ABSM-BDC-14.003           | SECTION VIEW OF PB & STRUCTURES                      |
| ABSM-BDC-14.004           | BREASTING DOLPHINS (Plan, Elevation<br>and Sections) |
| ABSM-BDC-14.005           | PRESTRESSED CONCRETE PILES                           |
| ABSM-BDC-14.006           | USED RUBBER TIRE FENDER                              |



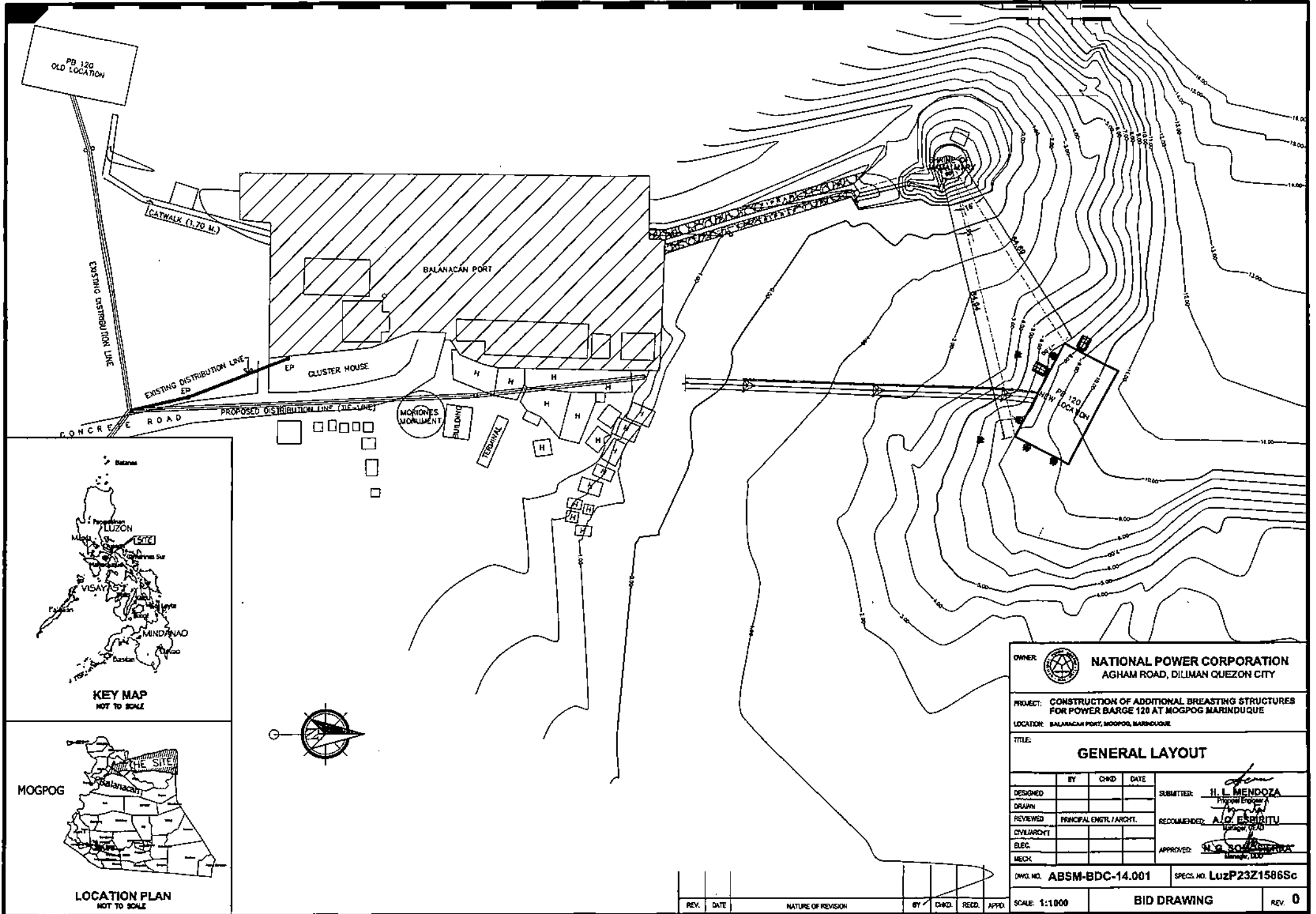

PB 120  
OLD LOCATION

CATWALK (1.70 M.)

BALANACAN PORT

CLUSTER HOUSE

MORIONES MONUMENT

BUILDING

TERMINAL

PB 120  
NEW LOCATION

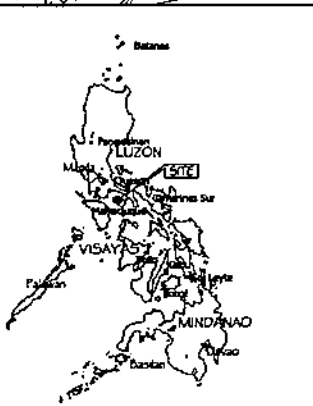

KEY MAP  
NOT TO SCALE

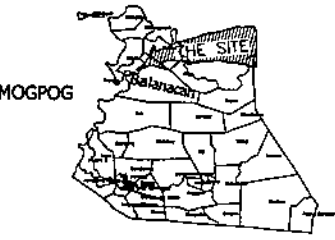
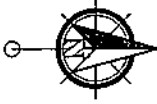





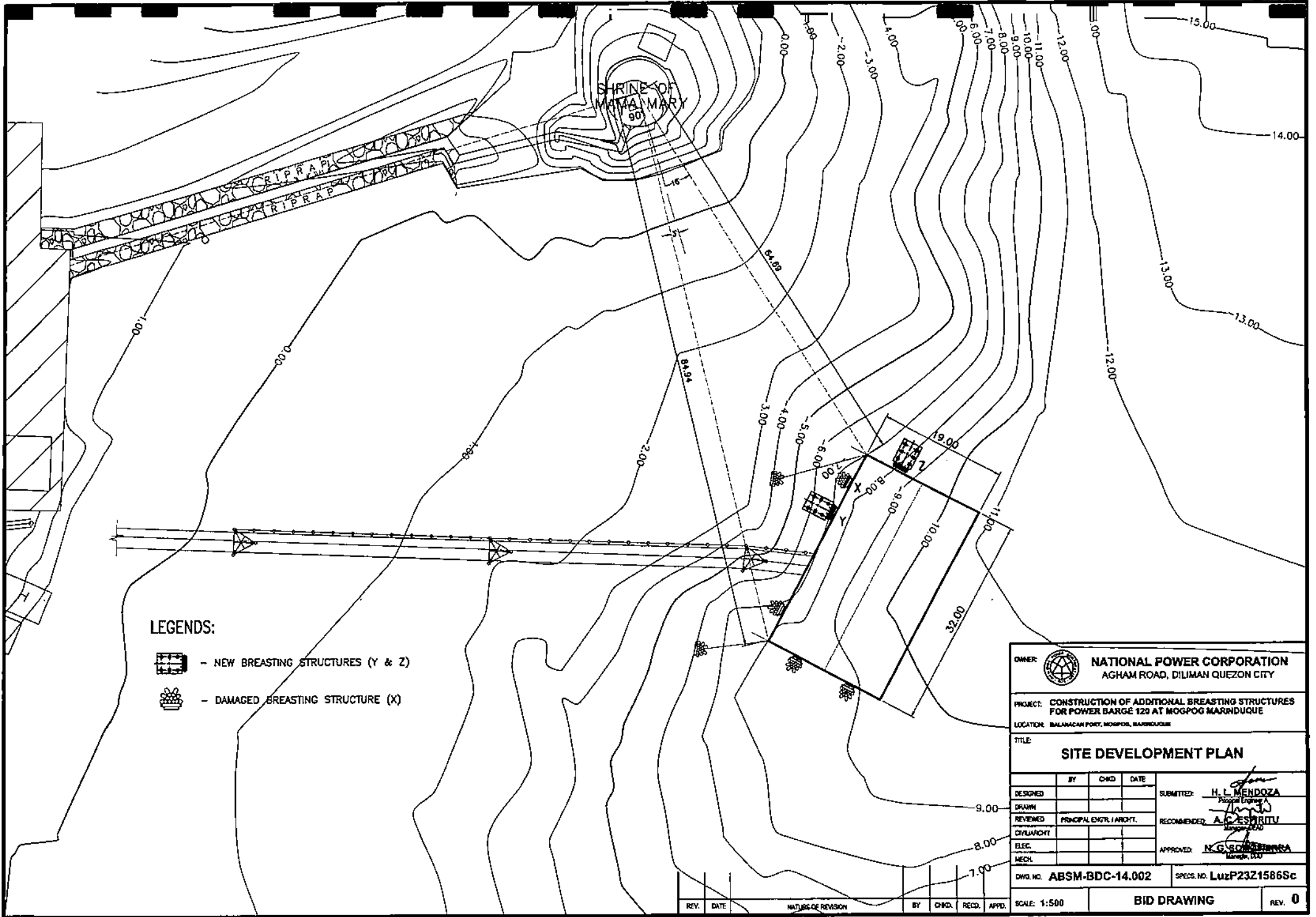

LOCATION PLAN  
NOT TO SCALE

|   |                         |   |   |
|---|-------------------------|---|---|
| OWNER:  |                         | NATIONAL POWER CORPORATION<br>AGHAM ROAD, DILIMAN QUEZON CITY |   |
| PROJECT: CONSTRUCTION OF ADDITIONAL BREASTING STRUCTURES FOR POWER BARGE 120 AT MOGPOG MARINDUQUE |                         |   |   |
| LOCATION: BALANACAN PORT, MOGPOG, MARINDUQUE  |                         |   |   |
| TITLE:<br><b>GENERAL LAYOUT</b>   |                         |   |   |
| DESIGNED  | BY                      | CHKD  | DATE  |
| DRAWN   |                         |   |   |
| REVIEWED  | PRINCIPAL ENGR./ ARCHT. |   | SUBMITTED: <i>H. L. MENDOZA</i><br>Principal Engineer |
| CIVIL/ARCHT.  |                         |   | RECOMMENDED: <i>A. D. ESPRITU</i><br>Manager          |
| ELEC.   |                         |   | APPROVED: <i>H. L. MENDOZA</i><br>Manager, IDU        |
| MECH.   |                         |   |   |
| DWG. NO. <b>ABSM-BDC-14.001</b>   |                         | SPEC. NO. <b>LuzP23Z1586Sc</b>                                |   |
| REV.  | DATE                    | NATURE OF REVISION  | BY  |
|   |                         |   | CHKD.   |
|   |                         |   | RECD.   |
|   |                         |   | APPD.   |
| SCALE: 1:1000   |                         | BID DRAWING   |   |
|   |                         |   | REV. 0  |



**LEGENDS:**

-  - NEW BREASTING STRUCTURES (Y & Z)
-  - DAMAGED BREASTING STRUCTURE (X)

|   |                          |  |  |
|---|--------------------------|--|--|
| OWNER:  |                          |  <b>NATIONAL POWER CORPORATION</b><br>AGHAM ROAD, DILIMAN QUEZON CITY |  |
| PROJECT: CONSTRUCTION OF ADDITIONAL BREASTING STRUCTURES FOR POWER BARGE 120 AT MOGPOG MARINDUQUE |                          |  |  |
| LOCATION: BALANACAN PORT, MORPOD, MARINDUQUE  |                          |  |  |
| TITLE: <b>SITE DEVELOPMENT PLAN</b>   |                          |  |  |
| DESIGNED  | BY                       | CHKD   | DATE   |
| DRAWN   |                          |  |  |
| REVIEWED  | PRINCIPAL ENGR. / ARCHT. |  | RECOMMENDED:   |
| CIVIL/ARCHT   |                          |  |  <b>H. L. MENDOZA</b><br>Principal Engineer, A  |
| ELEC.   |                          |  |  <b>A. C. ESPRITU</b><br>Manager, BDO           |
| MECH.   |                          |  | APPROVED:  <b>N. G. SORIANO</b><br>Manager, DDO |
| DWD. NO. <b>ABSM-BDC-14.002</b>   |                          | SPECS. NO. <b>LuzP23Z1586Sc</b>  |  |
| SCALE: 1:500  |                          | BID DRAWING  |  |
| REV. 0  |                          | REV. 0   |  |



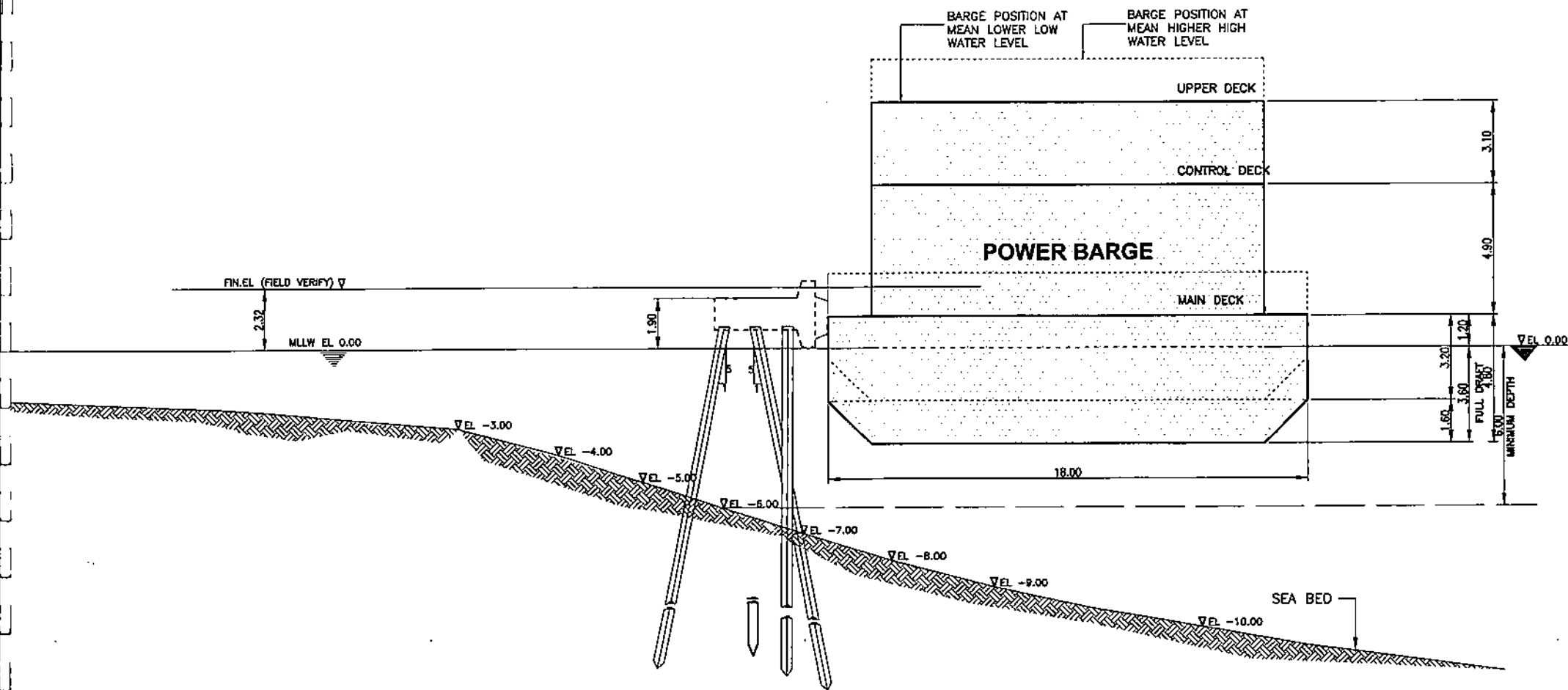

| REV. | DATE | NATURE OF REVISION | BY | CHKD. | RECD. | APPD. |
|------|------|--------------------|----|-------|-------|-------|
|      |      |                    |    |       |       |       |



**ELEVATION**  
SCALE 1:150

**NOTES:**

1. ALL DIMENSIONS AND ELEVATIONS ARE IN METERS UNLESS OTHERWISE INDICATED.
2. VERTICAL DATUM SHALL BE REFERRED TO MEAN LOWER LOW WATER (MLLW) WHICH IS EL 0.00
3. FIELD VERIFY THE PROPOSED EXACT LOCATION OF POWER BARGE TO CHECK THE MINIMUM REQUIRED WATER DEPTH PRIOR TO STAKING.

|              |                          |   |      |
|--------------|--------------------------|---|------|
| OWNER:       |                          |  <b>NATIONAL POWER CORPORATION</b><br>AGHAM ROAD, DILIMAN, QUEZON CITY |      |
| PROJECT:     |                          | CONSTRUCTION OF ADDITIONAL BREASTING STRUCTURES FOR POWER BARGE 120 AT MOGPOG MARINDUQUE  |      |
| LOCATION:    |                          | BALAKUAGAN PORT, MOGPOG, MARINDUQUE   |      |
| TITLE:       |                          | <b>SECTION VIEW OF PB AND STRUCTURES</b>  |      |
| DESIGNED     | BY                       | CHKD  | DATE |
| DRAWN        |                          |   |      |
| REVIEWED     | PRINCIPAL ENGR. / ARCHT. |   |      |
| CIVIL/ARCHT  |                          |   |      |
| ELEC         |                          |   |      |
| MECK         |                          |   |      |
| SUBMITTED:   |                          | <br><b>H.L. MENDOZA</b><br>Principal Engineer                          |      |
| RECOMMENDED: |                          | <br><b>A.O. ESPIRITU</b><br>Engineer                                   |      |
| APPROVED:    |                          | <br><b>N.G. SISON</b><br>Manager                                       |      |
| DWG. NO.     |                          | <b>ABSM-CNC-14.003</b>  |      |
| SPECS. NO.   |                          | <b>LuzP23Z1586Sc</b>  |      |
| SCALE:       |                          | <b>1:150</b>  |      |
| REV. NO.     |                          | <b>0</b>  |      |

| REV. | DATE | NATURE OF REVISION | BY | CHKD | RECD. | APPD. |
|------|------|--------------------|----|------|-------|-------|
|      |      |                    |    |      |       |       |

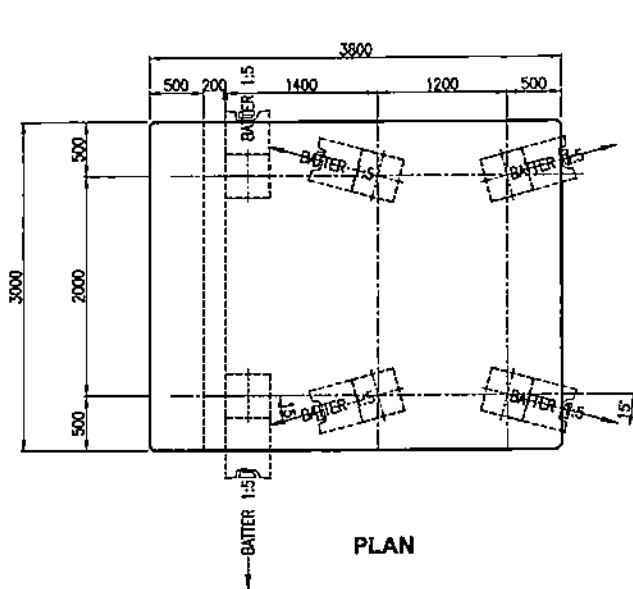

PLAN

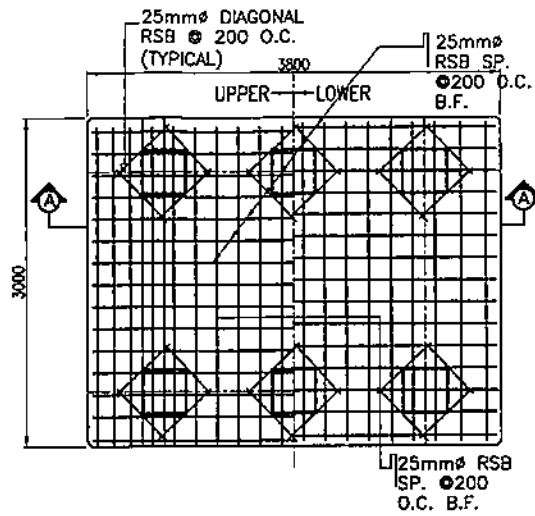

SECTION B-B

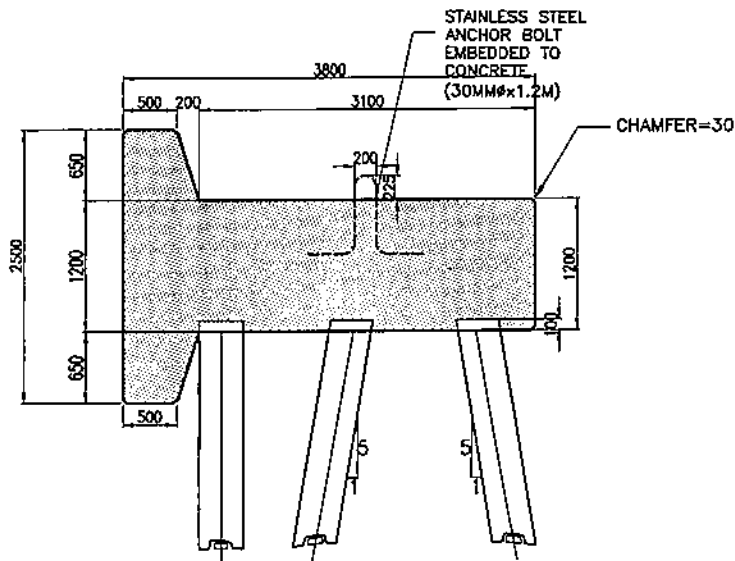



ELEVATION

TYPICAL BREASTING DOLPHIN

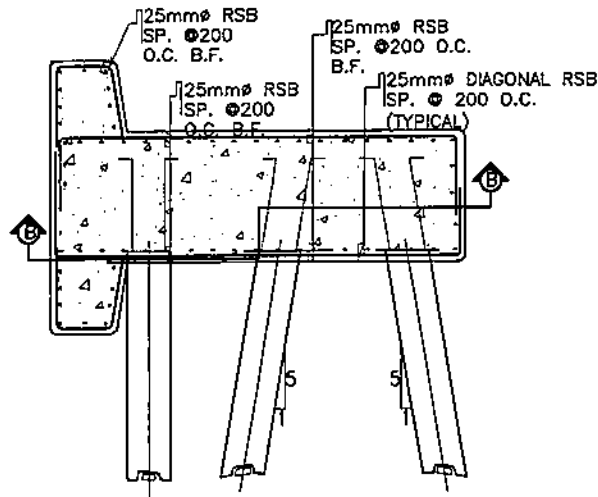
SCALE 1:50

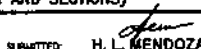

SECTION A-A

|   |                          |   |      |
|---|--------------------------|---|------|
| OWNER:  |                          |  <b>NATIONAL POWER CORPORATION</b><br>AGHAM ROAD, DILIMAN, QUEZON CITY |      |
| PROJECT: CONSTRUCTION OF ADDITIONAL BREASTING STRUCTURES FOR POWER BARGE 128 AT MOGPOG MARINDUQUE |                          |   |      |
| LOCATION: SALAMACAN PORT, MOGPOG, MARINDUQUE  |                          |   |      |
| TITLE: <b>BREASTING DOLPHINS</b><br>(PLAN, ELEVATION AND SECTIONS)                                |                          |   |      |
| DESIGNED  | BY                       | CHKD  | DATE |
| DRAWN   |                          |   |      |
| REVIEWED  | PRINCIPAL ENGR. / ARCHT. |   |      |
| CIVIL/ARCHT   |                          |   |      |
| ELEC.   |                          |   |      |
| MECH.   |                          |   |      |
| SUBMITTED:  |                          | <br>H. L. MENDOZA<br>Principal Engineer                                |      |
| RECOMMENDED:  |                          | <br>A. C. ESPIRITU<br>Civil Engr.                                      |      |
| APPROVED:   |                          | <br>N. G. SOMOSIERRA<br>Engr.  |      |
| DWG. NO. <b>ABSM-BDC-14.004</b>   |                          | SPECS. NO. <b>LuzP23Z1586Sc</b>   |      |
| SCALE: 1:150  |                          | BID DRAWING   |      |
| REV.  | DATE                     | NATURE OF REVISION  | BY   |
| CHKD.   | RECD.                    | APPD.   |      |
| REV. NO. 0  |                          |   |      |

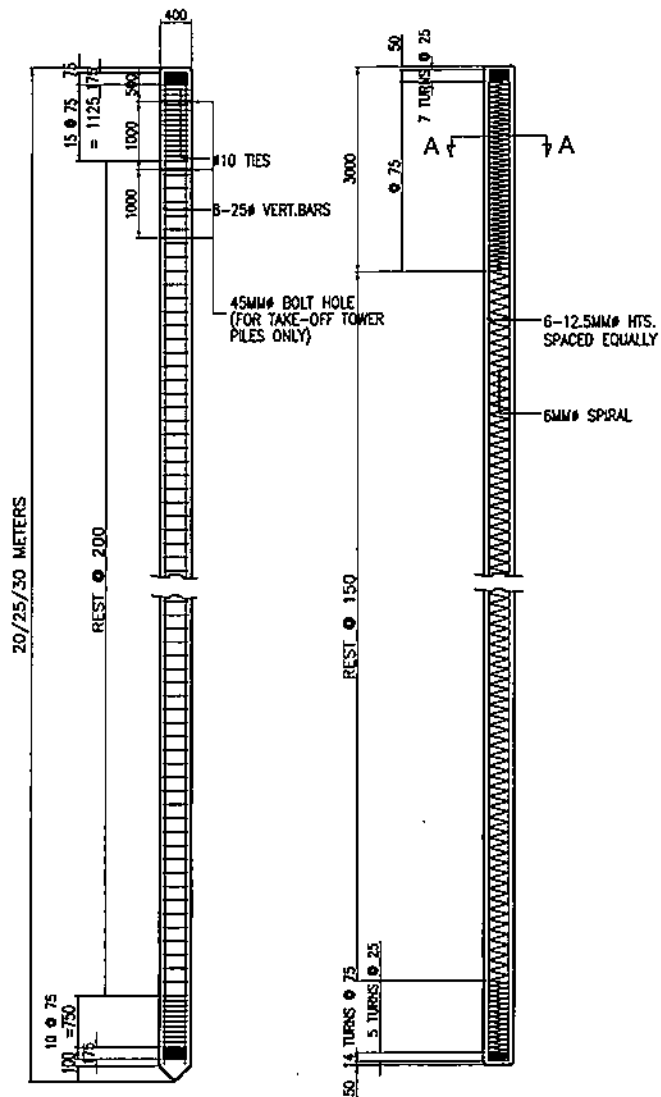

PILE ELEVATION SHOWING CAGE BAR & STEEL SPUD

PILE ELEVATION SHOWING SPIRAL REINFORCEMENT

**PRE-STRESSED CONCRETE PILES**  
SCALE 1:80

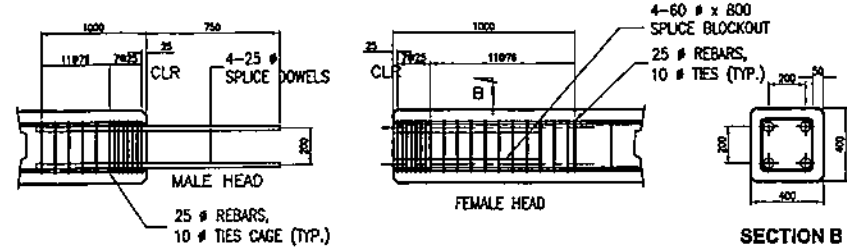

**PILE SPlicing DETAIL**  
SCALE 1:30

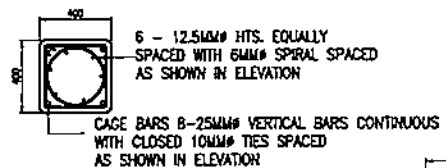

**SECTION A-A**

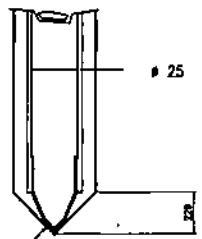

**PILE AND SPUD SECTION**  
SCALE 1:30

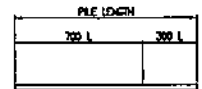

1 POINT PICK-UP

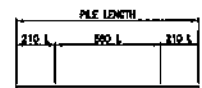

2 POINT PICK-UP

**LIFTING HOOK DETAIL**  
SCALE 1:30

|   |              |  |                |
|---|--------------|--|----------------|
| OWNER:  |              | NATIONAL POWER CORPORATION<br>AGHAM ROAD, OILIMAN, QUEZON CITY |                |
| PROJECT: CONSTRUCTION OF ADDITIONAL BREASTING STRUCTURES FOR POWER BARGE 120 AT MOGPOG MARINDUQUE |              |  |                |
| LOCATION: BALABAGAN PORT, MOGPOG, MARINDUQUE  |              |  |                |
| TITLE:<br><b>PRESTRESSED CONCRETE PILES</b>   |              |  |                |
| DESIGNED  | BY           | CHKD   | DATE           |
| DRAWN   | SUBMITTED:   |  | H. L. MENDOZA  |
| REVIEWED  | RECOMMENDED: |  | A. G. ESPARITU |
| CIVIL/ARCHT   | APPROVED:    |  | N. G. ESTERRA  |
| ELCC  |              |  |                |
| MECH  |              |  |                |
| DWG. NO. <b>ABSM-BDC-14.005</b>   |              | SPECS. NO. <b>LuzP23Z1586Sc</b>                                |                |

|      |      |                    |    |       |       |       |              |                    |            |
|------|------|--------------------|----|-------|-------|-------|--------------|--------------------|------------|
| REV. | DATE | NATURE OF REVISION | BY | CHKD. | RECD. | APPD. | SCALE: 1:150 | <b>BID DRAWING</b> | REV. NO. 0 |
|------|------|--------------------|----|-------|-------|-------|--------------|--------------------|------------|

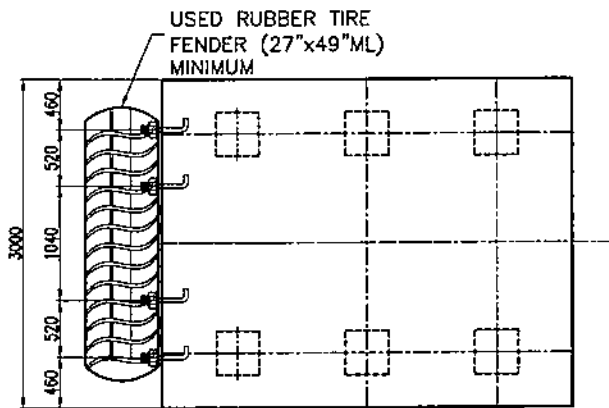

PLAN

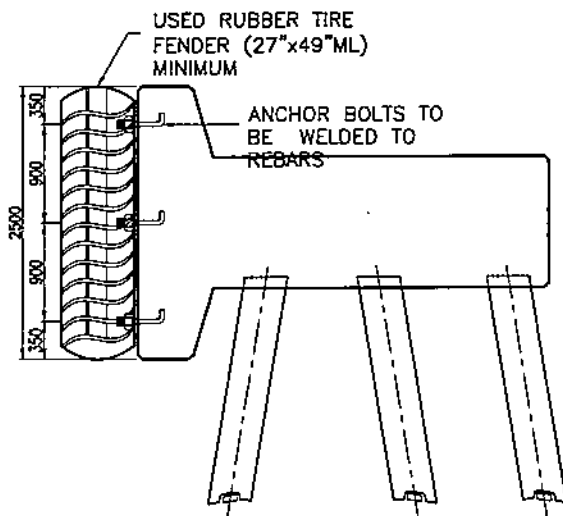

SIDE ELEVATION

30MMØX300 STAINLESS STEEL  
ANCHOR BOLT W/STAINLESS  
NUTS AND WASHERS  
USED RUBBER TIRE  
FENDER (27"x49"ML)  
MINIMUM

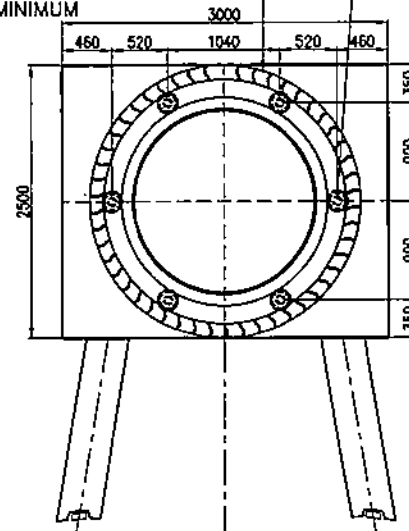

FRONT ELEVATION

**USED RUBBER TIRE FENDER**

SCALE 1:50

|   |                        |  |              |
|---|------------------------|--|--------------|
| OWNER:  |                        |  NATIONAL POWER CORPORATION<br>AGHAM ROAD, DILIMAN, QUEZON CITY |              |
| PROJECT: CONSTRUCTION OF ADDITIONAL BREASTING STRUCTURES FOR POWER BARGE 129 AT MOGPOG MARINDUQUE |                        |  |              |
| LOCATION: BALANACAN PORT, NEGROS, MARINDUQUE  |                        |  |              |
| TITLE:<br><b>USED RUBBER TIRE FENDER</b><br>(PLAN AND ELEVATION)                                  |                        |  |              |
| DESIGNED  | BY                     | CHKD   | DATE         |
| DRAWN   |                        |  |              |
| REVIEWED  | PRINCIPAL ENGR./ARCHT. |  | RECOMMENDED: |
| CIVIL/ARCHT   |                        |  |              |
| ELEC.   |                        |  | APPROVED:    |
| MECH.   |                        |  |              |
| DWG. NO. <b>ABSM-BDC-14.006</b>   |                        | SPEC. NO. <b>LuzP23Z1586Sc</b>   |              |
| SCALE: 1:150  |                        | <b>BID DRAWING</b>   |              |
| REV. NO. 0  |                        |  |              |

| REV. | DATE | NATURE OF REVISION | BY | CHKD | RECD. | APPO. |
|------|------|--------------------|----|------|-------|-------|
|      |      |                    |    |      |       |       |